

AMPCO Data Sheet

article#	A1232-7
article description	CEE-wall mounted socket 32A 3p 7h IP67
description long	CEE-wall mounted socket 32A 3p 7h IP67 housing material: PA6 rated current: 32A number of poles: 3 (2P+PE) clock-position: 7h rated voltage/frequency: 480-500V~ / 50+60Hz contacts: brass connection technology: screw terminals cable entry: top and rear incl. threaded cable gland IP protection class: IP67
GTIN (EAN)	9003399771019
country of origin	AT
customs number	85366990
net weight	0.298 kg
packaging quantity	5
minimum order quantity	5

ETIM 9.0	EC001321
Model	Surface mounted
IEC-amperage	32 A
Number of poles	3
Voltage according to EN 60309-2	500 V (50+60 Hz) black
Clock hour position	7 h
Identification colour	Black
Degree of protection (IP)	IP67
Connection system	Screwed terminal
Cable entry	Gland nut
Material	Plastic
Contact material	CuZn
Surface treatment contacts	Untreated
Type of fastening	External mounting

a	161 mm
b	108 mm
wire flexible	2,5-6 mm ²
wire solid	2,5-10 mm ²
contact screws	110 Ncm
connecting screws	110 Ncm
dismantling length	50 mm
stripping length	12-14 mm
ambient temperature	-25 – 40 °C
temperature resistance	-25 – 80 °C

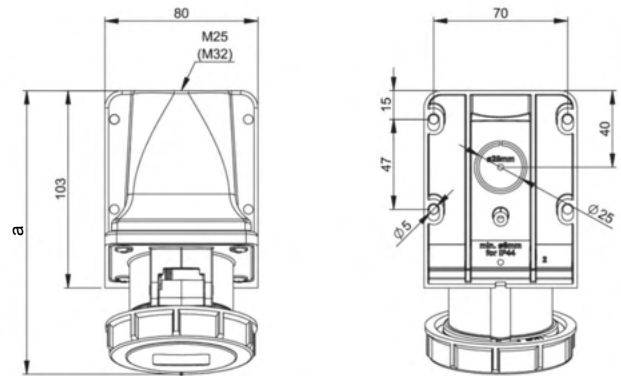

b=Höhe/height
Neigung/angle-15°

