



# HANDLING SYSTEM





# Since 1952 building the Future

REV. 01\_2021

## GIOVENZANA INTERNATIONAL B.V.

reserves the right to modify, as specifications change, all technical and functional characteristics of the products shown in this catalogue without prior notice as this information is intended for general knowledge and is not legally binding. All the images contained in this catalog are purely for explanatory purposes. The most up-to-date version of this catalogue can be downloaded from the download section of the website: [www.giovenzana.com](http://www.giovenzana.com)

## HISTORY

Founded in Italy in 1952, **Giovenzana** has gradually consolidated its experience in the field of **safety components** for industrial technologies. In the 1970s, Giovenzana began its path of **internationalization** by opening up to new European and International markets. The gradual expansion around the world has been combined with a growing diversification of its product range linked to the research for new business sectors. With **68 years of experience**, Giovenzana focused its strategy on creating innovative and reliable products that can anticipate the market needs.

## MISSION

Quality, competence and safety solutions have driven Giovenzana daily work, to develop the best products for all market requirements. Today its **high quality products** are recognizable all over the world. Giovenzana aims at environmental sustainability and energy efficiency. **Giovenzana mission is safety** above all by offering experience and expertise in designing reliable, ergonomic and intuitive safety devices. Its mission is to anticipate the different markets' needs to become a reference point for its customers. The intention is to create an ongoing link between the market and the company.

## MARKETING

Giovenzana sells to 75 countries and develops components in compliance with **European and International standards**. Giovenzana exports all over the world and manages its customers through a competent and available **global sales network**. The business relationship with customers is facilitated by a **structured back office** and the presence of a **renewed website** that guides the customer in the conscious choice of the right product.

## INNOVATION

Development, design and production are combined to achieve a common goal. **Giovenzana products are the result of innovation, experience and the daily application of own technological knowledge**. Over the years the company has constantly design new solutions by developing new skills and increasing the safety of its products.

## QUALITY & ENVIRONMENTAL POLICY

Attention for products quality, innovation researches and continuous development of new projects by our R&D department, represent our daily commitment. The commercial success of a product is the end result of the combined efforts of all human resources operating within an organizational structure that is devoted to quality. Today Giovenzana Quality Management System is based on processes according to **UNI ISO 9001:2015**, ensuring the coordination of all business activities, from design to production organisation, from purchases to sales, from after-sales assistance to dimensional and functional controls of samples and products. With the standard **UNI EN ISO 14001:2015** Giovenzana uses new technologies that limit the consumption of raw materials, energy and natural resources in order to minimize waste and emissions, protecting the environment. All the products are of certified quality and follow the guidelines Rohs, Pfos, Raee and Reach.

## R&D DEPARTMENT

The R&D department shall consist of specialized technicians, highly trained engineers, designers and researchers able to satisfy the technical needs of the customers. **The R&D Department works daily step by step, starting from the product design up to, through the various phases of prototyping,**

**verification and testing, to the final products.**

All these activities are carried out with the highest quality managements in order to satisfy the most stringent and restrictive product specifications. Use of advanced design software, prototyping machines and all the technical equipment of our test laboratory allows the company to develop new technologies implementing the most featured devices. **The R&D Department actively cooperates with the Consorzio Intellimech**, a private consortium of large, medium and small companies aimed at interdisciplinary research in the field of mechatronics.

## PRODUCTION

The solutions offered by Giovenzana derive from the company's extensive knowledge of the requirements of industrial electrical devices and are in line with all relevant International standards. Since 1952 Giovenzana creates, designs and produces safety solutions able to satisfy the needs of its customers within its business areas:

- **Handling system;**
- **Industrial Automation;**
- **Elevator and Escalator technology;**
- **Atex and IECEx equipment.**

## MANUFACTURING UNITS

Giovenzana International B.V. has **four manufacturing units**. The historical one in Italy, two others in Hungary and the new one in Brasil.













## LOGISTICS

Giovenzana, in order to support the market and its different necessities, has created a global organization that is always in process to cover territory in different hubs.

**PENDANT AND WALL-MOUNTED CONTROL STATIONS**

Pages 6 .. 65

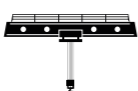
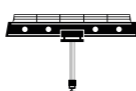
Ergonomic, resistant and flexible solutions for applications on cranes, hoists and other industrial lifting machinery. Available complete devices, custom kits, spare parts and accessories.

<p><b>P02</b></p>  <p><b>COMPLETE DEVICE</b> with two push buttons - single row for small hoist Pages 8 .. 11</p>	<p><b>P03</b></p>  <p><b>COMPLETE DEVICE</b> with three push buttons - single row for small hoist Pages 12 .. 15</p>	<p><b>HP03</b></p>  <p><b>COMPLETE DEVICE</b> with three push buttons for hoist ergonomic shape Pages 16 .. 19</p>	<p><b>HP05</b></p>  <p><b>COMPLETE DEVICE</b> with five push buttons for hoist ergonomic shape Pages 20 .. 23</p>	
<p><b>HP07</b></p>  <p><b>COMPLETE DEVICE</b> with seven push buttons for crane ergonomic shape Pages 24 .. 29</p>	<p><b>HP08</b></p>  <p><b>COMPLETE DEVICE</b> with eight push buttons for crane ergonomic shape Pages 30 .. 35</p>	<p><b>PLN</b></p>  <p><b>COMPLETE DEVICE</b> from 5 to 12 push buttons - single row for crane Pages 36 .. 47</p>	<p><b>TLP</b></p>  <p><b>COMPLETE DEVICE</b> from 1 to 4 push buttons - single row for truck tail lift Pages 48 .. 53</p>	
<p><b>P02K</b></p>  <p><b>CUSTOM KITS</b> with 2 holes single row</p>	<p><b>P03K</b></p>  <p><b>CUSTOM KITS</b> with 3 holes single row</p>	<p><b>PL .. K</b></p>  <p><b>CUSTOM KITS</b> from 5 to 12 holes single row Pages 54 .. 64</p>	<p><b>PLB .. K</b></p>  <p><b>CUSTOM KITS</b> from 4 to 14 holes double row</p>	<p><b>TLP .. K</b></p>  <p><b>CUSTOM KITS</b> from 1 to 5 holes single row</p>

**SPARE PARTS AND ACCESSORIES**

Page 65

**ROTARY GEAR LIMIT SWITCHES**

Pages 66 .. 89

Rotary gear limit switches represent a reliable solution as response to different exigencies of precision and durability, they are used to control specific motions in various industrial lifting machinery.

<p><b>FGR0</b></p>  <p>Pages 70 .. 74</p>	<p><b>FGR1</b></p>  <p>Pages 75 .. 78</p>	<p><b>FGR2</b></p>  <p>Pages 79 .. 82</p>	<p><b>FGR3</b></p>  <p>Pages 83 .. 85</p>
------------------------------------------------------------------------------------------------------------------------------	------------------------------------------------------------------------------------------------------------------------------	------------------------------------------------------------------------------------------------------------------------------	------------------------------------------------------------------------------------------------------------------------------

**SPARE PARTS AND ACCESSORIES**

Pages 86 .. 89

**POSITION LIMIT SWITCHES**

Pages 90 .. 101

Position limit switches are used particularly in industrial and construction lifting plants, in the automation industry, in stage technology, in particular for the control of overhead travelling cranes, jib cranes and machine tools.

<p><b>FFH</b></p>  <p>Pages 94 .. 95</p>	<p><b>FCR</b></p>  <p>Pages 96 .. 97</p>	<p><b>FFH2C-1</b></p>  <p>Pages 98 .. 99</p>	<p><b>FCP245</b></p>  <p>Pages 100 .. 101</p>
-------------------------------------------------------------------------------------------------------------------------------	-------------------------------------------------------------------------------------------------------------------------------	-----------------------------------------------------------------------------------------------------------------------------------	------------------------------------------------------------------------------------------------------------------------------------

**SLIP RINGS**

Pages 102 .. 103

The slip rings are used in electromechanical devices including rotary tables, carousels for recreational entertainment and in general to feed organs of machinery in circular motion.

**SCUDO**



Pages 102 .. 103

**WARNING HORNS**

Pages 104 .. 105

Audible signaling devices.

**G**



Pages 104 .. 105

# PENDANT CONTROL STATIONS

Giovenzana International B.V. has over 65 years of experience in designing and manufacturing pendant control stations and wall-mounted control stations for auxiliary and direct control, used to command and control industrial machinery. They are characterized by an ergonomic user-friendly design, an high protection class degree and high operating reliability and switching capacity. They are suitable in different sizes with a wide range of operating and switching components for various applications.

## APPLICATIONS

- **Industrial and construction lifting plants** to control gantry cranes, track cranes, jib cranes, wall-mounted jib cranes, tower cranes and winches for construction sites;
- **Automation industry** to command and control systems to manage machines and processes;
- **Waste disposal industry** to control the movement of machines and equipment.

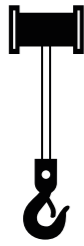

HOIST

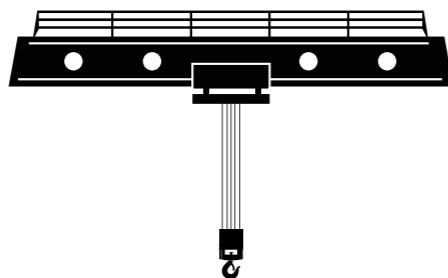

CRANE



TRUCK TAIL LIFT

## Safety operating control for handling system

Giovenzana International B.V. pendant control stations and wall-mounted control stations - for universal operation of cranes, hoists and machinery - are available as **complete devices** or in **kit versions** that allows to design a tailor made product, totally customizable for every customers' needs and requirements.

The range includes different configurations (from 2 to 14 push buttons) with spare parts and accessories, such as emergency push buttons, key and lever selector switches, push buttons with laser symbolism, single led lamps. Equipped with contact support, also interlocked, to facilitate wiring.

The components are available with a high degree of protection against weather effects, high mechanical and electrical durability and resistance. All components have to be reliable and safe to ensure good handling control, guarantee maximum operating safety, prevent personal injuries and damage to objects.

The complete range of pendant stations is CE marked. On request our pendant stations - complete devices - could be UL certified for the American market, EAC certified for the Eurasian markets, CCC certified suitable for the Chinese market, to the quality levels required in different countries. All our electrical parts are manufactured in compliance with the Directives and Standards in conformity to global markets' needs.

## FEATURES

- Available complete devices (A) or custom kits (B) to be assembled using separated components and common accessories;



- Functions: 1 or 2 speed up, 6 movements, start/alarm push button, emergency stop option available;
- Complies with IEC standards;
- CE, CCC, EAC marked;
- Available with UL/CSA requirements, upon request also in V0 material, UL approved;
- Spring loaded or screw clamp connection.

## BENEFITS

### › High protection

IP65 Protection class degree

### › Standard and customized configuration

Different sizes with wide range of operating and switching components

Tailor made configuration and combination

### › Easy use, resistance and durability

Ergonomic user-friendly design in various configurations from 2 to 14 operating elements

### › Guaranteed safety

Certified contact elements for auxiliary and direct control

High operating reliability and switching capacity

## SERIES



# P02

## Pendant control station

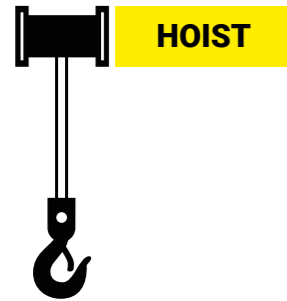

























### Single row pendant control station with two push buttons for small hoist

#### Features

- Bi-directionality is mechanically interlocked;
- IP65 Double insulation (IEC / EN 60529);
- Laser engraved symbols according to EN 60204-1, FEM 9.941;
- Shock proof and heat resistant;
- Available versions: for single or double speed engines and direct control 1 kW - 1 speed;
- Available with UL/CSA requirements;
- Available upon request also in V0 material, UL approved;
- Available in kit version.

#### Available codes

Available codes						
<b>P02.RM</b> Single speed						
<b>P02.1</b> Single speed						
<b>P02.2</b> Single speed						
<b>P02.4</b> Single speed						
<b>P02.CD</b> Direct control / Single speed						
<b>P02.D2</b> Double speed						

#### Compliance and certifications

- EN 60947-1 (2007/A1 : 2011/A2 : 2014)
- EN 60947-5-1 (2004/A1 : 2009/AC : 2004/AC : 2005)
- EN ISO 13850 (2015)
- EN 60204-1 (2006/A1 : 2009)
- EN-ISO 13849-1 (2015)
- EN ISO 13849-2 (2012)
- EN 60529 (1991/A1 : 2000/A2 : 2013)
- EN 50581 (2012)
- IEC 63000 (2016)
- 2014/35/UE
- 2011/65/UE
- 2015/863/UE

#### Technical data

General characteristics		
Compliant to standards		IEC / EN60947-5-1
Material		PP
Material Group		II
Pollution class		3
Temperature	operating storage	-25°C ... +70°C -30°C ... +70°C
Cable entry		rubber cable sleeve Ø 7 ... 18 mm

#### Electrical characteristics - Contact blocks

Marking		 (For contacts by direct control only CE certification is valid)	
Rated insulation voltage [Ui]		690 V *	
Rated impulse withstand voltage [Uimp]		4 kV *	
Frequency		50/60 Hz *	
Rated thermal current [Ith]		16 A *	
Rated thermal current in enclosure [Ithe]		10 A	
<b>Rated operational current [Ie]</b>			
AC-15 alternate current	type: PL0040..	24 V	16 A *
		60 V	12 A
		120 V	8 A
		240 V	6 A
		400 V	4.5 A
		440 V	3.5 A
		500 V	3 A *
		690 V	1 A
DC-13 direct current	type: PL0040..	24 V	2 A *
		48 V	1.2 A
		60 V	0.85 A
		110 V	0.4 A
		220 V	0.25 A *
Conditional short circuit withstand current		1000 A *	
Fuses rating gC		10 A * - 500 V	
Contact insulation resistance		≤ 25 mΩ	
Switching mechanism	type: PL0040..	slow break double gap contacts	
Positive operation		NC contact blocks - positive opening	
Operating force		4 N	
Electric durability AC-15		1 A	1.5 millions of cycles
		2 A	0.5 millions of cycles
		3 A	0.25 millions of cycles
Terminal type	type: PL0040..	M3.5 screw terminals	
Terminal capacity	type: PL0040..	N° 1 or 2 flexible and solid conductor 1 ... 2.5 mm <sup>2</sup>	
Climate resistance	IEC68 part 2-3 IEC68 part 2-30	damp heat, steady state damp heat, cyclic	

#### UL508 characteristics

Rated insulation voltage [Ui]		10 A - 600 V ac / 2.5 A - 125 V dc
Rated impulse withstand voltage [Uimp]		A600-Q600

\* IMQ approved values

# P02

## Pendant control station







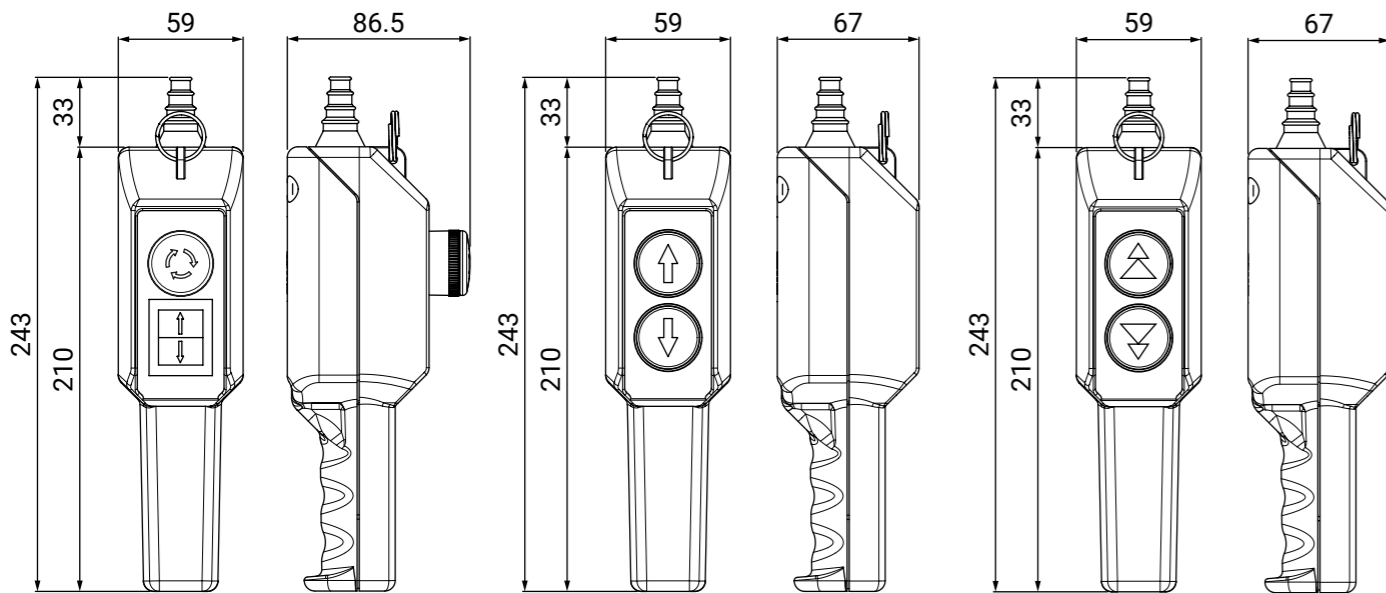























Available codes



<b>P02.RM</b>	<b>P02.1 P02.2 P02.4 P02.CD</b>	<b>P02.D2</b>
---------------	---------------------------------------------	---------------



Standard versions

PRODUCT CODE	FUNCTION	LAYOUT	PUSH BUTTON	CONTACT CONFIGURATION
<b>P02.RM</b>	Single speed			 1 NC
				 ON - OFF - ON
<b>P02.1</b>	Single speed			 1 NO
				 1 NO
<b>P02.2</b>	Single speed			 2 NO
				 2 NO
<b>P02.4</b>	Single speed			 1 NC + 1 NO
				 1 NC + 1 NO
<b>P02.CD</b>	Direct control Single speed			 1 NC + 2 NO
				 1 NC + 2 NO
<b>P02.D2</b>	Double speed			 NO + NO
				 NO + NO

**CONTACT CODE**

Single speed



**PL004001**



**PL004002**



**11708237**

Single speed  
Direct control



**PL004001CD**



**PL004002CD**

Double speed



**PL004010.S**

# P03

## Pendant control station

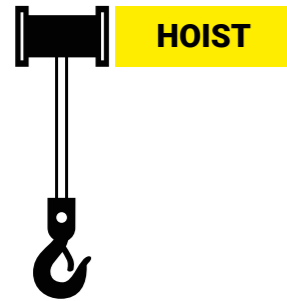

### Single row pendant control station with three push buttons for small hoist

#### Features

- Bi-directionality is mechanically interlocked;
- IP65 Double insulation (IEC / EN 60529);
- Laser engraved symbols according to EN 60204-1, FEM 9.941;
- Shock proof and heat resistant;
- Available versions: for single or double speed motors and direct control 1 kW - 1 speed;
- Available with UL/CSA requirements;
- Available upon request also in V0 material, UL approved;
- Available in kit version.

#### Available codes

<b>P03.1</b> Single speed					
<b>P03.2</b> Single speed					
<b>P03.3</b> Single speed					
<b>P03CD</b> Direct control / Single speed					
<b>P03D2</b> Double speed					

#### Compliance and certifications

- EN 60947-1 (2007/A1 : 2011/A2 : 2014)
- EN 60947-5-1 (2004/A1 : 2009/AC : 2004/AC : 2005)
- EN ISO 13850 (2015)
- EN 60204-1 (2006/A1 : 2009)
- EN-ISO 13849-1 (2015)
- EN ISO 13849-2 (2012)
- EN 60529 (1991/A1 : 2000/A2 : 2013)
- EN 50581 (2012)
- IEC 63000 (2016)
- 2014/35/UE
- 2011/65/UE
- 2015/863/UE

#### Technical data

General characteristics		
Compliant to standards		IEC / EN60947-5-1
Material		ABS
Material Group		II
Pollution class		3
Temperature	operating storage	-25°C ... +70°C -30°C ... +70°C
Cable entry		rubber cable sleeve Ø 7 ... 18 mm

#### Electrical characteristics - Contact blocks

Marking		 (For contacts by direct control only CE certification is valid)	
Rated insulation voltage [Ui]		690 V *	
Rated impulse withstand voltage [Uimp]		4 kV *	
Frequency		50/60 Hz *	
Rated thermal current [Ith]		16 A *	
Rated thermal current in enclosure [Ithe]		10 A	
<b>Rated operational current [Ie]</b>			
AC-15 alternate current	type: PL0040..	24 V	16 A *
		60 V	12 A
		120 V	8 A
		240 V	6 A
		400 V	4.5 A
		440 V	3.5 A
		500 V	3 A *
		690 V	1 A
DC-13 direct current	type: PL0040..	24 V	2 A *
		48 V	1.2 A
		60 V	0.85 A
		110 V	0.4 A
		220 V	0.25 A *
Conditional short circuit withstand current		1000 A *	
Fuses rating gG		10 A * - 500 V	
Contact insulation resistance		≤ 25 mΩ	
Switching mechanism	type: PL0040..	slow break double gap contacts	
Positive operation		NC contact blocks - positive opening	
Operating force		4 N	
Electric durability AC-15		1 A	1.5 millions of cycles
		2 A	0.5 millions of cycles
		3 A	0.25 millions of cycles
Terminal type	type: PL0040..	M3.5 screw terminals	
Terminal capacity	type: PL0040..	N° 1 or 2 flexible and solid conductor 1 ... 2.5 mm <sup>2</sup>	
Climate resistance	IEC68 part 2-3 IEC68 part 2-30	damp heat, steady state damp heat, cyclic	

#### UL508 characteristics

Rated insulation voltage [Ui]		10 A - 600 V ac / 2.5 A - 125 V dc
Rated impulse withstand voltage [Uimp]		A600-Q600

\* IMQ approved values

# P03

## Pendant control station

Available codes



**P03.1 (P03.1N - black version)**  
**P03.2**  
**P03.3**  
**P03CD**

**P03D2**

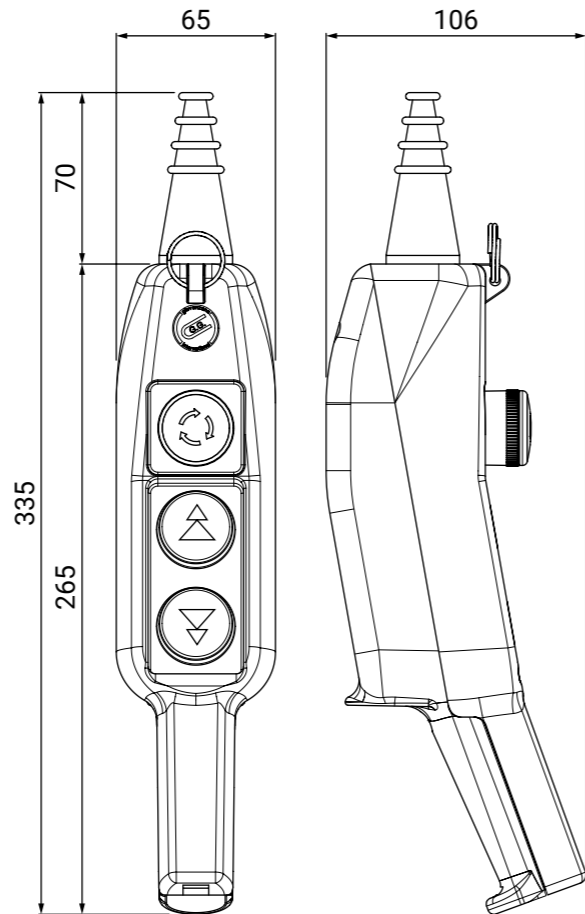
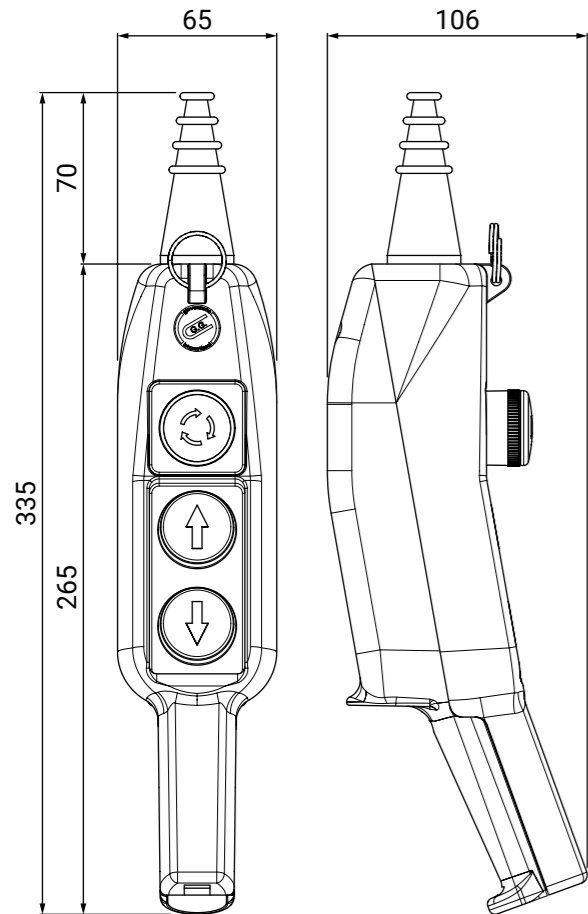

### Standard versions

PRODUCT CODE	FUNCTION	LAYOUT	PUSH BUTTON	CONTACT CONFIGURATION
<b>P03.1</b> <b>P03.1N</b>	Single speed			1 NC
				1 NO
				1 NO
<b>P03.2</b>	Single speed			1 NC
				2 NO
				2 NO
<b>P03.3</b>	Single speed			1 NC
				3 NO
				3 NO
<b>P03CD</b>	Direct control Single speed			2 NC + 1 NO
				1 NC + 2 NO
				1 NC + 2 NO
<b>P03D2</b>	Double speed			1 NC
				NO + NO
				NO + NO

### CONTACT CODE

Single speed



1 NC

**PL004001**



1 NO

**PL004002**

Single speed  
Direct control



1 NC

**PL004001CD**



1 NO

**PL004002CD**

Double speed



NO + NO

**PL004010.S**



# HP03

## Pendant control station

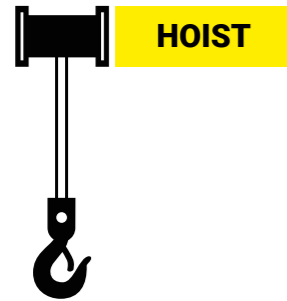

### Ergonomic pendant control station with three push buttons for hoist

#### Features

- Bi-directionality is mechanically interlocked;
- IP65 Double insulation (IEC / EN 60529);
- Laser engraved symbols according to EN 60204-1, FEM 9.941;
- Shock proof and heat resistant;
- Available versions: for single or double speed motors;
- Available with UL/CSA requirements.

#### Available codes

<b>HP03</b> Single speed					
<b>HP03.D2</b> Double speed					

#### Compliance and certifications

- EN 60947-1 (2007/A1 : 2011/A2 : 2014)
- EN 60947-5-1 (2004/A1 : 2009/AC : 2004/AC : 2005)
- EN ISO 13850 (2015)
- EN 60204-1 (2006/A1 : 2009)
- EN-ISO 13849-1 (2015)
- EN ISO 13849-2 (2012)
- EN 60529 (1991/A1 : 2000/A2 : 2013)
- EN 50581 (2012)
- IEC 63000 (2016)
- 2014/35/UE
- 2011/65/UE
- 2015/863/UE



### Technical data

General characteristics		
Compliant to standards		IEC / EN60947-5-1
Material		ABS V0
Material Group		II
Pollution class		3
Temperature	operating storage	-25°C ... +70°C -30°C ... +70°C
Cable entry		Spiral cable gland M20

### Electrical characteristics - Contact blocks

Marking							
Rated insulation voltage [Ui]		690 V *					
Rated impulse withstand voltage [Uimp]		4 kV *					
Frequency		50/60 Hz *					
Rated thermal current [Ith]		16 A *					
Rated thermal current in enclosure [Ithe]		10 A					
<b>Rated operational current [Ie]</b>							
AC-15 alternate current	type: PCW..	24 V	16 A *	60 V	12 A	110 V	5 A
		240 V	5 A *	400 V	4 A	440 V	4 A
		500 V	4 A *	690 V	2 A		
DC-13 direct current	type: PCW..	24 V	2 A	48 V	2 A *	60 V	1 A *
		110 V	0.4 A	250 V	0.4 A *		
Minimum constant current		1 mA@5Vdc, 1 mA@24Vdc					
Conditional short circuit withstand current		1000 A *					
Fuses rating gC		10 A * - 500 V					
Contact insulation resistance		≤ 25 mΩ					
Switching mechanism	type: PCW..	slow break double gap contacts					
Positive operation		NC contact blocks - positive opening					
Operating force		4 N					
Electric durability AC-15		1 A	1.5 millions of cycles	2 A	0.5 millions of cycles	3 A	0.25 millions of cycles
Terminal type	type: PCW..	M3.5 screw terminals					
Terminal capacity	type: PCW..	N° 1 or 2 flexible and solid conductor 1 ... 2.5 mm²					
Climate resistance	IEC68 part 2-3 IEC68 part 2-30	damp heat, steady state damp heat, cyclic					

### UL508 characteristics

Rated insulation voltage [Ui]		10 A - 600 V ac / 2.5 A - 125 V dc
Rated impulse withstand voltage [Uimp]		A600-Q600

\* IMQ approved values

Available codes

# HP03

## Pendant control station









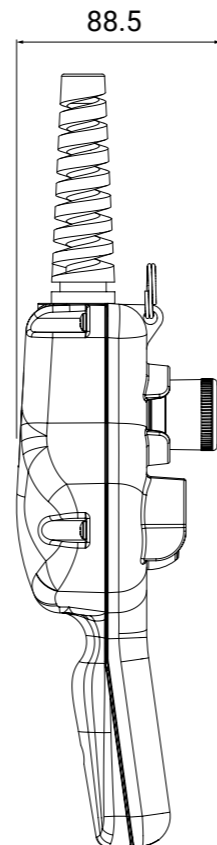
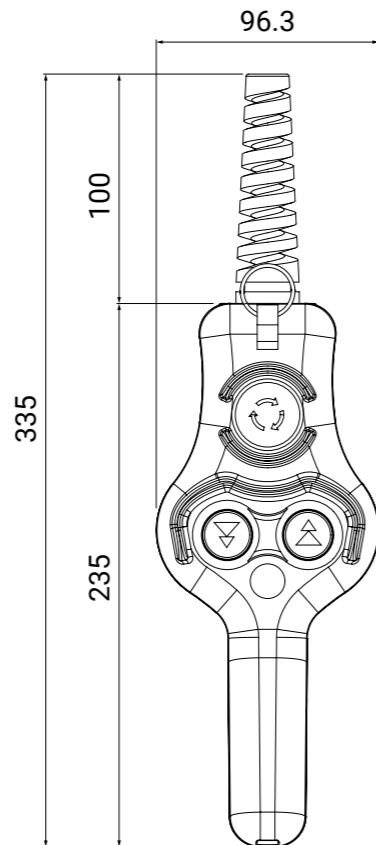
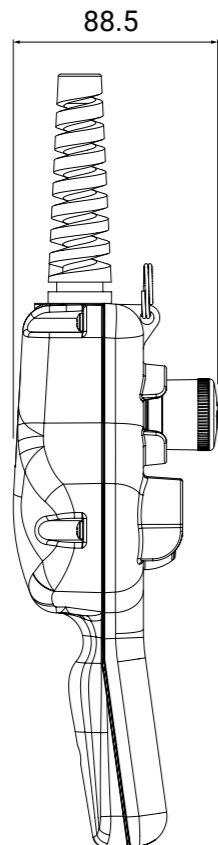
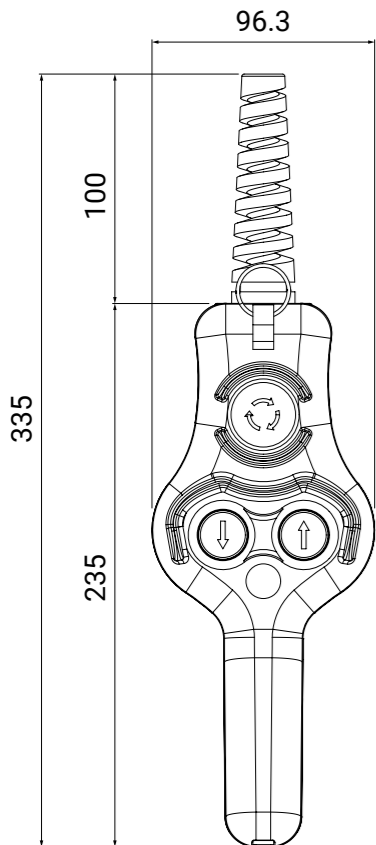







**HP03**



**HP03.D2**



### Standard versions

PRODUCT CODE	FUNCTION	LAYOUT	PUSH BUTTON	CONTACT CONFIGURATION
<b>HP03</b>	Single speed			 1 NC
				 1 NO
				 1 NO
<b>HP03.D2</b>	Double speed			 1 NC
				 NO + NO
				 NO + NO

**CONTACT CODE**

Single speed



**PCW01**



**PCW10**

Double speed



**PCWDS**

# HP05

## Pendant control station

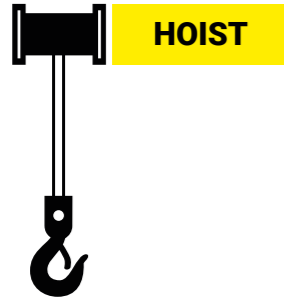









### Ergonomic pendant control station with five push buttons for hoist

#### Features

- Bi-directionality is mechanically interlocked;
- IP65 Double insulation (IEC / EN 60529);
- Laser engraved symbols according to EN 60204-1, FEM 9.941;
- Shock proof and heat resistant;
- Available versions: for single or double speed motors;
- Available with UL/CSA requirements.

#### Available codes

Available codes									
HP05 Single speed	NC	NO	NO	NO	NO				
HP05.D2 Single/Double speed	NC			NO	NO	NO+NO	NO+NO		
HP05.D4 Double speed	NC					NO+NO	NO+NO	NO+NO	NO+NO

#### Compliance and certifications







- EN 60947-1 (2007/A1 : 2011/A2 : 2014)
- EN 60947-5-1 (2004/A1 : 2009/AC : 2004/AC : 2005)
- EN ISO 13850 (2015)
- EN 60204-1 (2006/A1 : 2009)
- EN-ISO 13849-1 (2015)
- EN ISO 13849-2 (2012)
- EN 60529 (1991/A1 : 2000/A2 : 2013)
- EN 50581 (2012)
- IEC 63000 (2016)
- 2014/35/UE
- 2011/65/UE
- 2015/863/UE



#### Technical data

General characteristics		
Compliant to standards		IEC / EN60947-5-1
Material		ABS V0
Material Group		II
Pollution class		3
Temperature	operating storage	-25°C ... +70°C -30°C ... +70°C
Cable entry		Cable gland M25

#### Electrical characteristics - Contact blocks

Marking		     
Rated insulation voltage [Ui]		690 V *
Rated impulse withstand voltage [Uimp]		4 kV *
Frequency		50/60 Hz *
Rated thermal current [Ith]		16 A *
Rated thermal current in enclosure [Ithe]		10 A
<b>Rated operational current [Ie]</b>		
AC-15 alternate current	type: PCW..	24 V 16 A * 60 V 12 A 110 V 5 A 240 V 5 A * 400 V 4 A 440 V 4 A 500 V 4 A * 690 V 2 A
DC-13 direct current	type: PCW..	24 V 2 A 48 V 2 A * 60 V 1 A * 110 V 0.4 A 250 V 0.4 A *
Minimum constant current		1 mA@5Vdc, 1 mA@24Vdc
Conditional short circuit withstand current		1000 A *
Fuses rating gC		10 A * - 500 V
Contact insulation resistance		≤ 25 mΩ
Switching mechanism	type: PCW..	slow break double gap contacts
Positive operation		NC contact blocks - positive opening
Operating force		4 N
Electric durability AC-15		1 A 1.5 millions of cycles 2 A 0.5 millions of cycles 3 A 0.25 millions of cycles
Terminal type	type: PCW..	M3.5 screw terminals
Terminal capacity	type: PCW..	N° 1 or 2 flexible and solid conductor 1 ... 2.5 mm <sup>2</sup>
Climate resistance	IEC68 part 2-3 IEC68 part 2-30	damp heat, steady state damp heat, cyclic

#### UL508 characteristics

Rated insulation voltage [Ui]		10 A - 600 V ac / 2.5 A - 125 V dc
Rated impulse withstand voltage [Uimp]		A600-Q600

\* IMQ approved values

# HP05

## Pendant control station

### Available codes









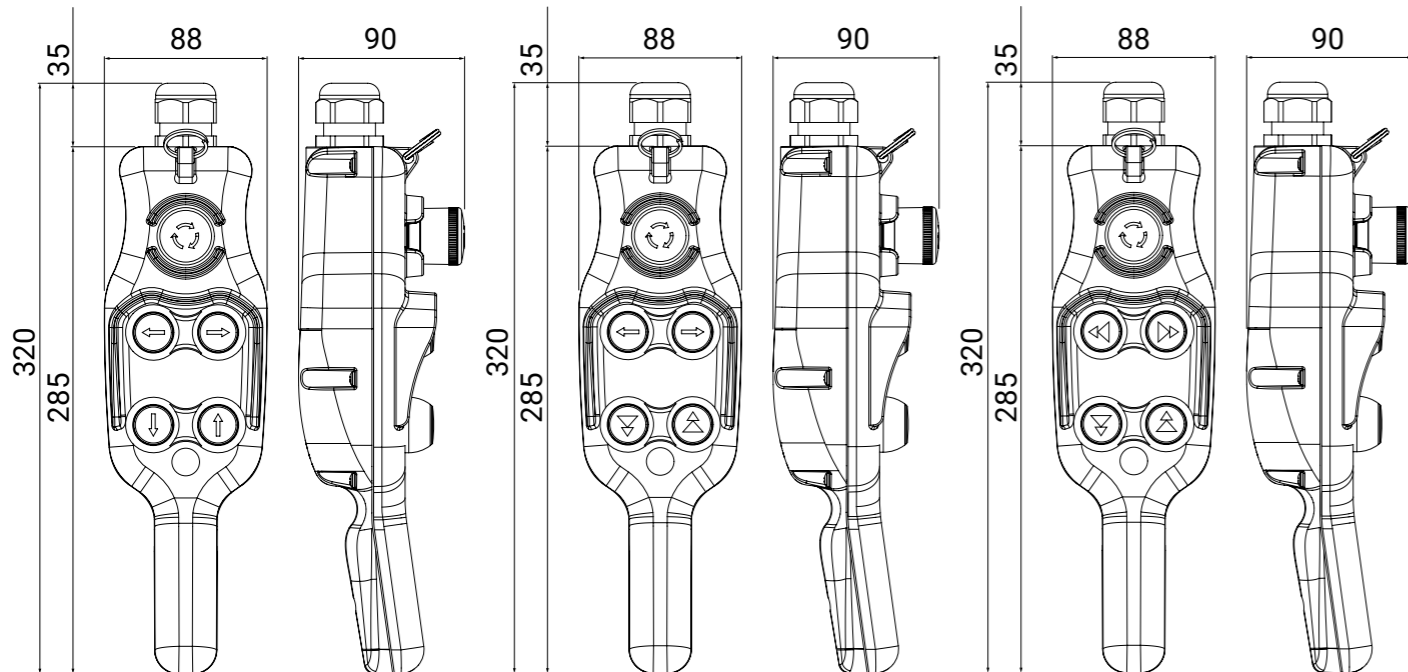

























**HP05**

**HP05.D2**

**HP05.D4**



### Standard versions

PRODUCT CODE	FUNCTION	LAYOUT	PUSH BUTTON	CONTACT CONFIGURATION
<b>HP05</b>	Single speed			 1 NC
				 1 NO
				 1 NO
				 1 NO
				 1 NO
<b>HP05.D2</b>	Single/Double speed			 1 NC
				 1 NO
				 1 NO
				 NO + NO
				 NO + NO
<b>HP05.D4</b>	Double speed			 1 NC
				 NO + NO
				 NO + NO
				 NO + NO
				 NO + NO

### CONTACT CODE

#### Single speed



1 NC

#### PCW01



1 NO

#### PCW10

#### Double speed



NO + NO

#### PCWDS

# HP07

## Pendant control station

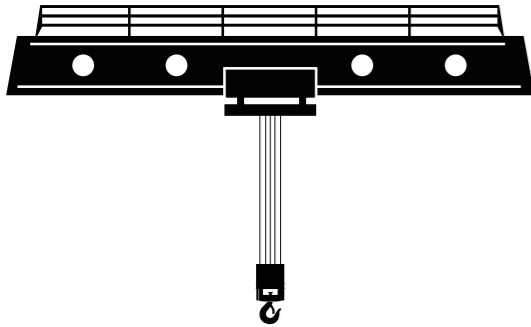













CRANE

### Ergonomic pendant control station with seven push buttons for crane

#### Features

- Bi-directionality is mechanically interlocked;
- IP65 Double insulation (IEC / EN 60529);
- Laser engraved symbols according to EN 60204-1, FEM 9.941;
- Shock proof and heat resistant;
- Available versions: for single or double speed motors;
- Available with UL/CSA requirements.

#### Available codes

													
<b>HP07</b> Single speed	NC	NO	NO	NO	NO	NO	NO						
<b>HP07.D2</b> Single/double speed	NC	NO	NO			NO	NO			NO+NO	NO+NO		
<b>HP07.D4</b> Single/double speed	NC	NO	NO							NO+NO	NO+NO	NO+NO	NO+NO
<b>HP07.D6</b> Double speed	NC									NO+NO	NO+NO	NO+NO	NO+NO







#### Compliance and certifications

- EN 60947-1 (2007/A1 : 2011/A2 : 2014)
- EN 60947-5-1 (2004/A1 : 2009/AC : 2004/AC : 2005)
- EN ISO 13850 (2015)
- EN 60204-1 (2006/A1 : 2009)
- EN-ISO 13849-1 (2015)
- EN ISO 13849-2 (2012)
- EN 60529 (1991/A1 : 2000/A2 : 2013)
- EN 50581 (2012)
- IEC 63000 (2016)
- 2014/35/UE
- 2011/65/UE
- 2015/863/UE

#### Technical data

General characteristics		
Compliant to standards		IEC / EN60947-5-1
Material		ABS V0
Material Group		II
Pollution class		3
Temperature	operating storage	-25°C ... +70°C -30°C ... +70°C
Cable entry		Cable gland M25

#### Electrical characteristics - Contact blocks

Marking		     
Rated insulation voltage [Ui]		690 V *
Rated impulse withstand voltage [Uimp]		4 kV *
Frequency		50/60 Hz *
Rated thermal current [Ith]		16 A *
Rated thermal current in enclosure [Ithe]		10 A
<b>Rated operational current [Ie]</b>		
AC-15 alternate current	type: PCW..	24 V 16 A * 60 V 12 A 110 V 5 A 240 V 5 A * 400 V 4 A 440 V 4 A 500 V 4 A * 690 V 2 A
DC-13 direct current	type: PCW..	24 V 2 A 48 V 2 A * 60 V 1 A * 110 V 0.4 A 250 V 0.4 A *
Minimum constant current		1 mA@5Vdc, 1 mA@24Vdc
Conditional short circuit withstand current		1000 A *
Fuses rating gC		10 A * - 500 V
Contact insulation resistance		≤ 25 mΩ
Switching mechanism	type: PCW..	slow break double gap contacts
Positive operation		NC contact blocks - positive opening
Operating force		4 N
Electric durability AC-15		1 A 1.5 millions of cycles 2 A 0.5 millions of cycles 3 A 0.25 millions of cycles
Terminal type	type: PCW..	M3.5 screw terminals
Terminal capacity	type: PCW..	N° 1 or 2 flexible and solid conductor 1 ... 2.5 mm <sup>2</sup>
Climate resistance	IEC68 part 2-3 IEC68 part 2-30	damp heat, steady state damp heat, cyclic

#### UL508 characteristics

Rated insulation voltage [Ui]		10 A - 600 V ac / 2.5 A - 125 V dc
Rated impulse withstand voltage [Uimp]		A600-Q600

\* IMQ approved values

Available codes



**HP07**



**HP07.D2**



**HP07.D4**



**HP07.D6**

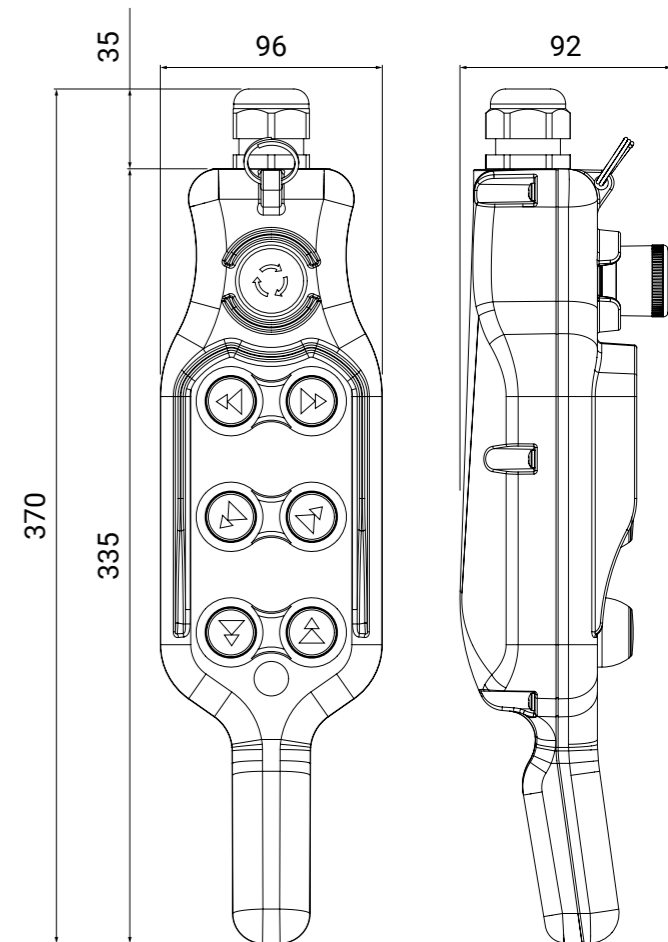
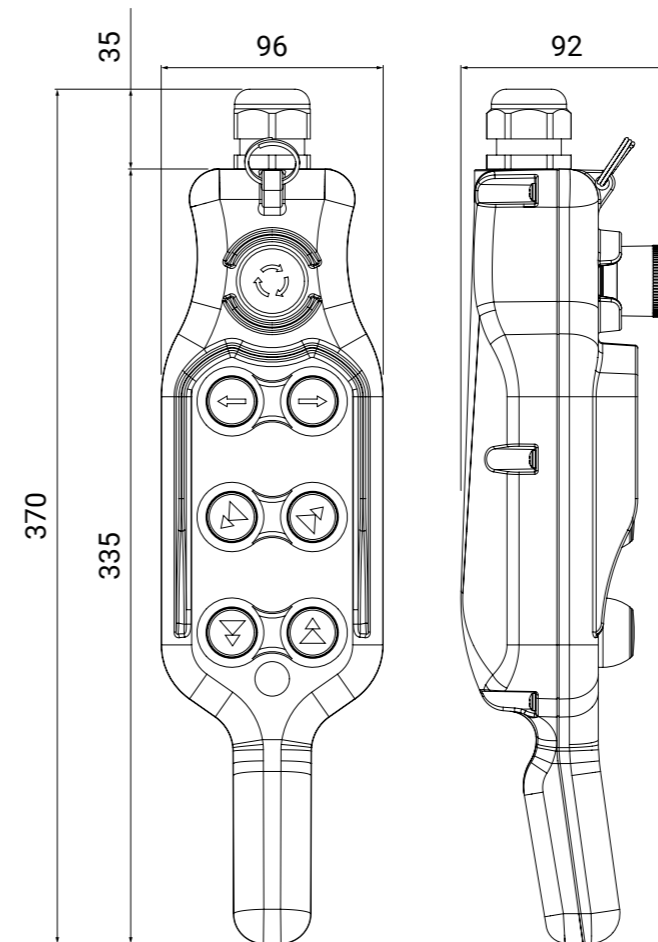
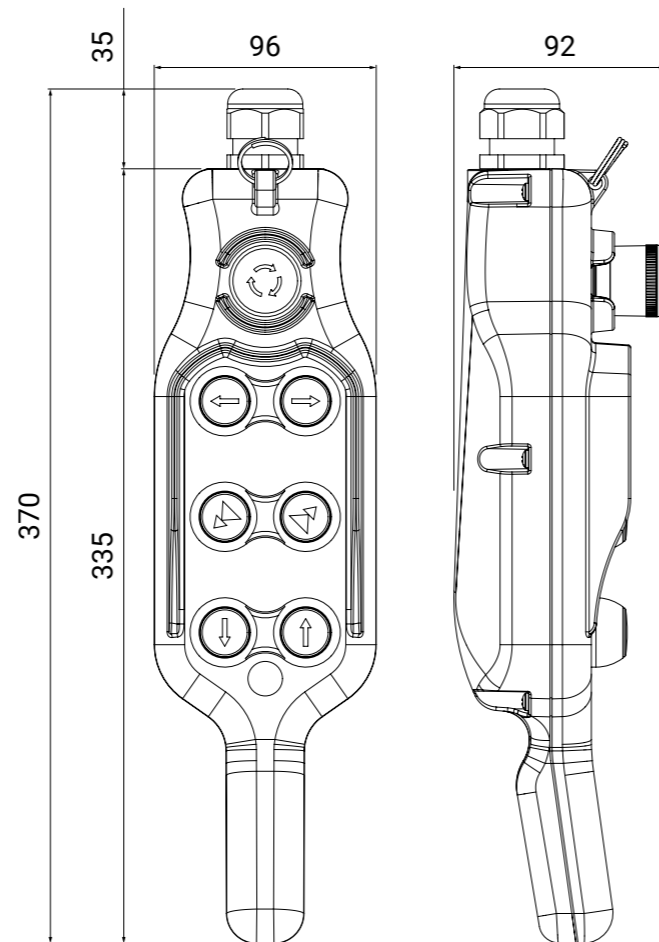
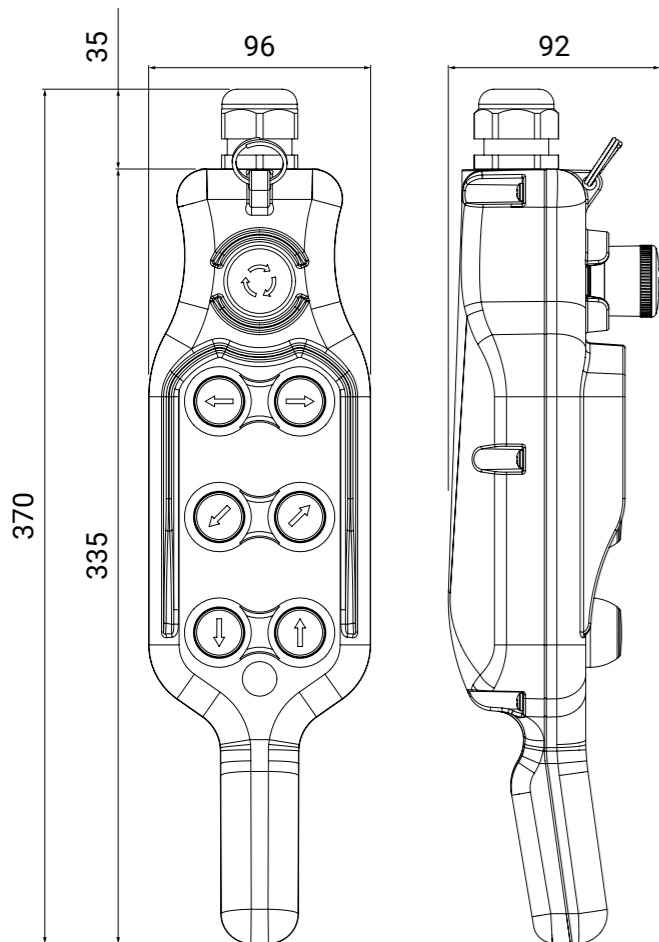



























# HP07

Pendant control station

PENDANT STATIONS



























Available codes

Standard versions

PRODUCT CODE	FUNCTION	LAYOUT	PUSH BUTTON	CONTACT CONFIGURATION
<b>HP07</b>	Single speed			 1 NC
				 1 NO
				 1 NO
				 1 NO
				 1 NO
				 1 NO
				 1 NO
			<b>HP07.D2</b>	Single/Double speed
	 1 NO			
	 1 NO			
	 NO + NO			
	 NO + NO			
	 1 NO			
	 1 NO			

CONTACT CODE
Single speed
 1 NC <b>PCW01</b>
 1 NO <b>PCW10</b>
Double speed
 NO + NO <b>PCWDS</b>

Standard versions

PRODUCT CODE	FUNCTION	LAYOUT	PUSH BUTTON	CONTACT CONFIGURATION
<b>HP07.D4</b>	Single/Double speed			 1 NC
				 1 NO
				 1 NO
				 NO + NO
				 NO + NO
				 NO + NO
				 NO + NO
			<b>HP07.D6</b>	Double speed
	 NO + NO			
	 NO + NO			
	 NO + NO			
	 NO + NO			
	 NO + NO			
	 NO + NO			

CONTACT CODE
Single speed
 1 NC <b>PCW01</b>
 1 NO <b>PCW10</b>
Double speed
 NO + NO <b>PCWDS</b>

# HP08

## Pendant control station

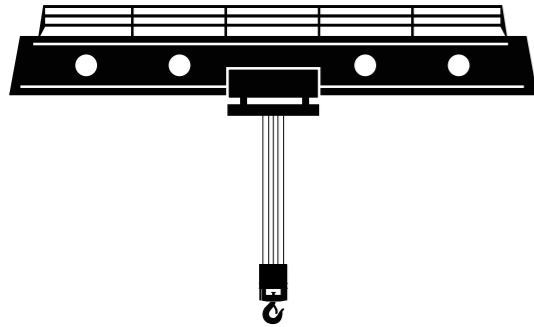













CRANE

### Ergonomic pendant control station with eight holes for crane

#### Features

- Bi-directionality is mechanically interlocked;
- IP65 Double insulation (IEC / EN 60529);
- Laser engraved symbols according to EN 60204-1, FEM 9.941;
- Shock proof and heat resistant;
- Available versions: for single or double speed engines;
- Available with UL/CSA requirements.

#### Available codes

													
<b>HP08</b> Single speed	NC	NO NO	NO	NO	NO	NO	NO	NO					
<b>HP08.D2</b> Single/double speed	NC	NO NO	NO	NO			NO	NO			NO+NO	NO+NO	
<b>HP08.D4</b> Single/double speed	NC	NO NO	NO	NO							NO+NO	NO+NO	NO+NO
<b>HP08.D6</b> Double speed	NC	NO NO									NO+NO	NO+NO	NO+NO







#### Compliance and certifications

- EN 60947-1 (2007/A1 : 2011/A2 : 2014)
- EN 60947-5-1 (2004/A1 : 2009/AC : 2004/AC : 2005)
- EN ISO 13850 (2015)
- EN 60204-1 (2006/A1 : 2009)
- EN-ISO 13849-1 (2015)
- EN ISO 13849-2 (2012)
- EN 50581 (2012)
- IEC 63000 (2016)
- 2014/35/UE
- 2011/65/UE
- 2015/863/UE

#### Technical data

General characteristics		
Compliant to standards		IEC / EN60947-5-1
Material		ABS V0
Material Group		II
Pollution class		3
Temperature	operating storage	-25°C ... +70°C -30°C ... +70°C
Cable entry		Cable gland M32

#### Electrical characteristics - Contact blocks

Marking		     
Rated insulation voltage [Ui]		690 V *
Rated impulse withstand voltage [Uimp]		4 kV *
Frequency		50/60 Hz *
Rated thermal current [Ith]		16 A *
Rated thermal current in enclosure [Ithe]		10 A
<b>Rated operational current [Ie]</b>		
AC-15 alternate current	type: PCW..	24 V 16 A * 60 V 12 A 110 V 5 A 240 V 5 A * 400 V 4 A 440 V 4 A 500 V 4 A * 690 V 2 A
DC-13 direct current	type: PCW..	24 V 2 A 48 V 2 A * 60 V 1 A * 110 V 0.4 A 250 V 0.4 A *
Minimum constant current		1 mA@5Vdc, 1 mA@24Vdc
Conditional short circuit withstand current		1000 A *
Fuses rating gC		10 A * - 500 V
Contact insulation resistance		≤ 25 mΩ
Switching mechanism	type: PCW..	slow break double gap contacts
Positive operation		NC contact blocks - positive opening
Operating force		4 N
Electric durability AC-15		1 A 1.5 millions of cycles 2 A 0.5 millions of cycles 3 A 0.25 millions of cycles
Terminal type	type: PCW..	M3.5 screw terminals
Terminal capacity	type: PCW..	N° 1 or 2 flexible and solid conductor 1 ... 2.5 mm <sup>2</sup>
Climate resistance	IEC68 part 2-3 IEC68 part 2-30	damp heat, steady state damp heat, cyclic

#### UL508 characteristics

Rated insulation voltage [Ui]		10 A - 600 V ac / 2.5 A - 125 V dc
Rated impulse withstand voltage [Uimp]		A600-Q600

\* IMQ approved values



Available codes



**HP08**



**HP08.D2**



**HP08.D4**



**HP08.D6**







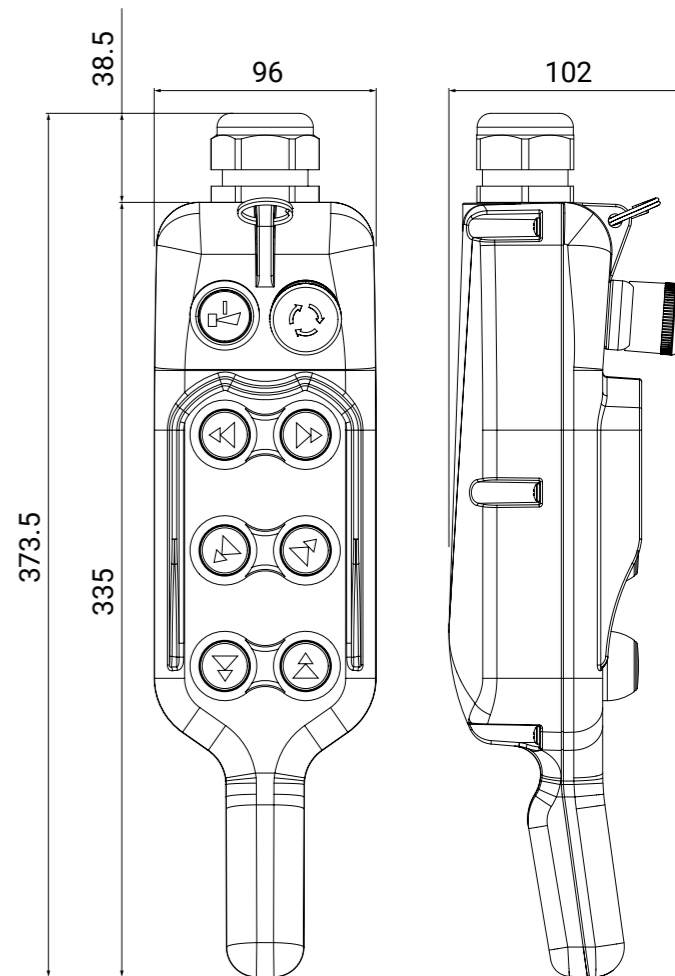
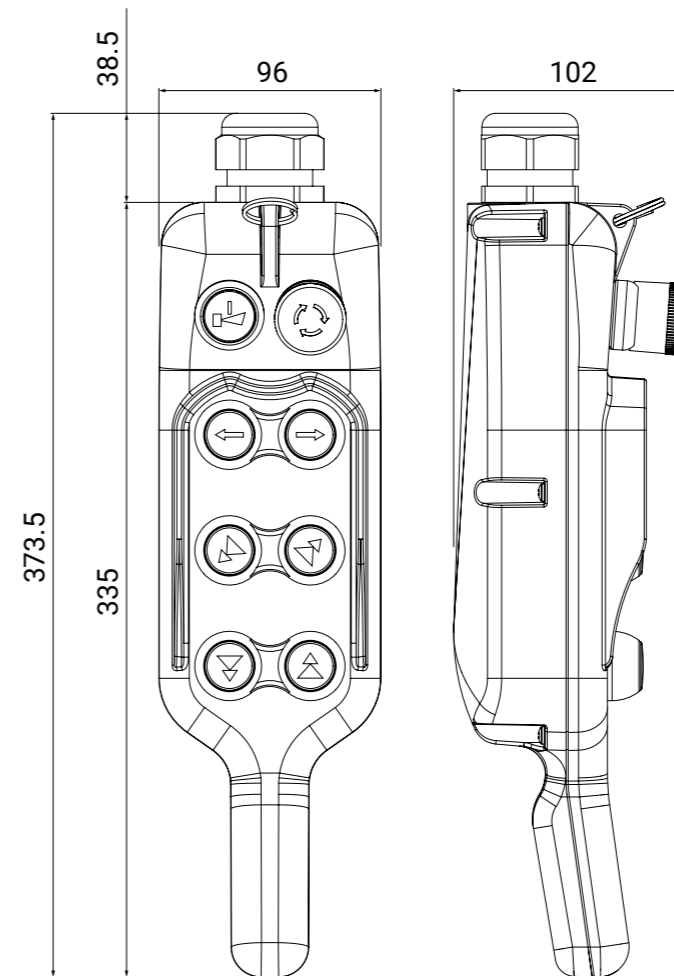
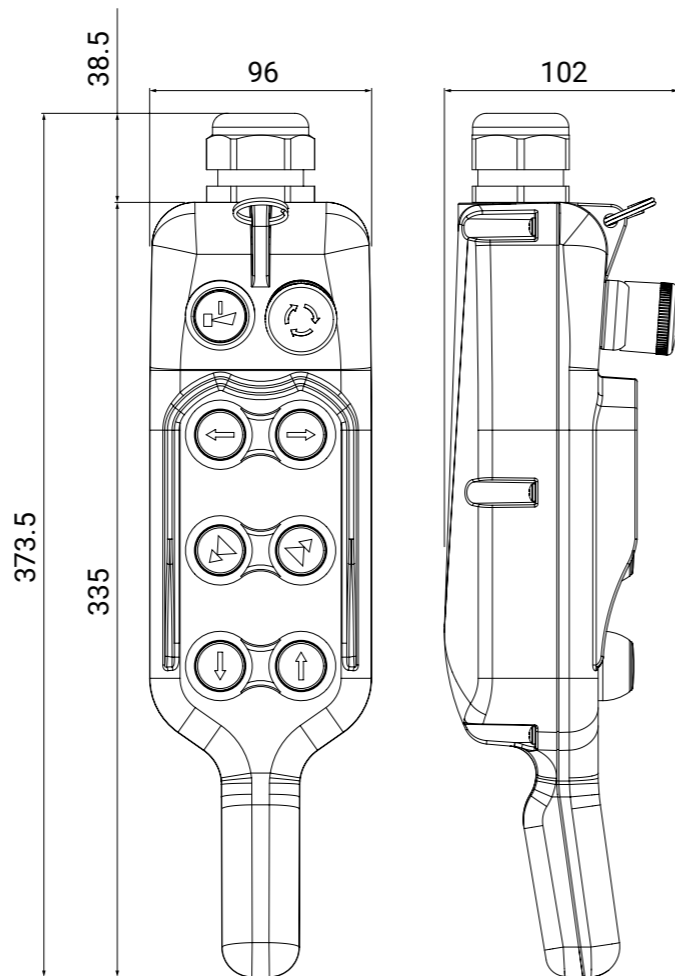
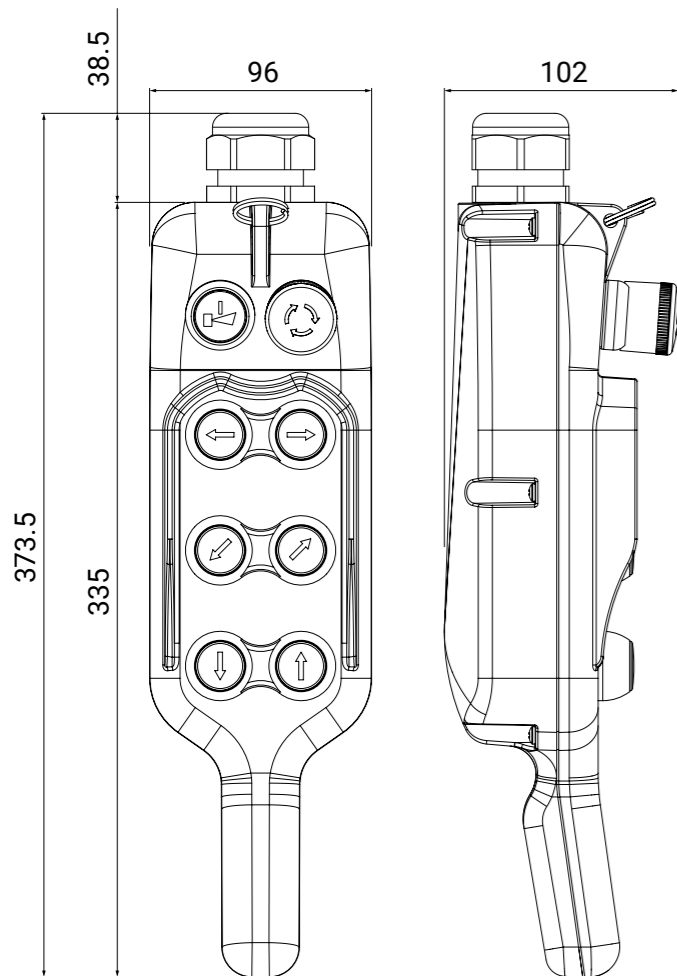























# HP08

Pendant control station

PENDANT STATIONS





































**Standard versions**

PRODUCT CODE	FUNCTION	LAYOUT	PUSH BUTTON	CONTACT CONFIGURATION
<b>HP08</b>	Single speed			 2 NO
				 1 NC
				 1 NO
				 1 NO
				 1 NO
				 1 NO
				 1 NO
				 1 NO
			<b>HP08.D2</b>	Single/Double speed
	 1 NC			
	 1 NO			
	 1 NO			
	 NO + NO			
	 NO + NO			
	 1 NO			
	 1 NO			

CONTACT CODE
Single speed
 1 NC
<b>PCW01</b>
 1 NO
<b>PCW10</b>
Double speed
 NO + NO
<b>PCWDS</b>

**Standard versions**

PRODUCT CODE	FUNCTION	LAYOUT	PUSH BUTTON	CONTACT CONFIGURATION			
<b>HP08.D4</b>	Single/Double speed			 2 NO			
				 1 NC			
				 1 NO			
				 1 NO			
				 NO + NO			
				 NO + NO			
				 NO + NO			
				 NO + NO			
			<b>HP08.D6</b>	Double speed			 2 NO
							 1 NC
	 NO + NO						
	 NO + NO						
	 NO + NO						
	 NO + NO						
	 NO + NO						
	 NO + NO						

CONTACT CODE
Single speed
 1 NC
<b>PCW01</b>
 1 NO
<b>PCW10</b>
Double speed
 NO + NO
<b>PCWDS</b>

# PLN

## Pendant control station

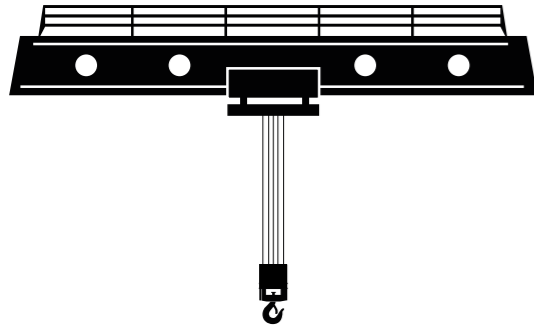

Single row pendant control station  
from 5 to 12 push buttons for crane

CRANE



5 PUSH BUTTONS

7 PUSH BUTTONS

8 PUSH BUTTONS

10 PUSH BUTTONS

12 PUSH BUTTONS

### Features

- Bi-directionality is mechanically interlocked;
- IP65 Double insulation (IEC / EN 60529);
- Laser engraved symbols with laser marking according to EN 60204-1, FEM 9.941;
- Shock proof and heat resistant;
- Available versions: for single or double speed motors;
- Available with UL/CSA requirements, upon request also in V0 material, UL approved;
- Available in kit version (with PLN or PL laser engraved push buttons).

### Available codes

																
PLN05 Single speed	NC	NO	NO	NO	NO											
PLN05D2 Single/double speed	NC			NO	NO										NO+NO	NO+NO
PLN05D4 Double speed	NC									NO+NO	NO+NO				NO+NO	NO+NO
PLN07 Single speed	NC	NO	NO	NO	NO	NO	NO									
PLN07D2 Single/double speed	NC	NO	NO	NO	NO								NO+NO	NO+NO		
PLN07D4 Single/double speed	NC			NO	NO								NO+NO	NO+NO	NO+NO	NO+NO
PLN07D6 Double speed	NC									NO+NO	NO+NO	NO+NO	NO+NO	NO+NO	NO+NO	
PLN08 Single speed	NC	NO	NO	NO	NO	NO	NO	NO								
PLN08D2 Single/double speed	NC	NO	NO	NO	NO	NO							NO+NO	NO+NO		
PLN08D4 Single/double speed	NC	NO			NO	NO							NO+NO	NO+NO	NO+NO	NO+NO
PLN08D6 Double speed	NC	NO								NO+NO	NO+NO	NO+NO	NO+NO	NO+NO	NO+NO	
PLN10 Single/double speed	NC	NO	NO	NO	NO	NO	NO	NO			NO	NO				
PLN12 Single/double speed	NC	NO	NO	NO	NO	NO	NO	NO	NO	NO	NO	NO	NO			

### Compliance and certifications

- EN 60947-1 (2007/A1 : 2011/A2 : 2014)
- EN 60947-5-1 (2004/A1 : 2009/AC : 2004/AC : 2005)
- EN ISO 13850 (2015)
- EN 60204-1 (2006/A1 : 2009)
- EN-ISO 13849-1 (2015)
- EN ISO 13849-2 (2012)
- EN 60529 (1991/A1 : 2000/A2 : 2013)
- EN 50581 (2012)
- IEC 63000 (2016)
- 2014/35/UE
- 2011/65/UE
- 2015/863/UE

**Technical data**

**General characteristics**

Compliant to standards		IEC / EN60947-5-1
Material		ABS
Material Group		II
Pollution class		3
Temperature	operating storage	-25°C ... +70°C -30°C ... +70°C
Cable entry		rubber cable sleeve Ø 9 ... 24 mm

**Electrical characteristics - Contact blocks**

Marking		
Rated insulation voltage [Ui]		690 V *
Rated impulse withstand voltage [Uimp]		4 kV *
Frequency		50/60 Hz *
Rated thermal current [Ith]		16 A *
Rated thermal current in enclosure [Ithe]		10 A
<b>Rated operational current [Ie]</b>		
AC-15 alternate current	type: PL0040..	24 V 16 A * 60 V 12 A 120 V 8 A 240 V 6 A 400 V 4.5 A 440 V 3.5 A 500 V 3 A * 690 V 1 A
DC-13 direct current	type: PL0040..	24 V 2 A * 48 V 1.2 A 60 V 0.85 A 110 V 0.4 A 220 V 0.25 A *
Conditional short circuit withstand current		1000 A *
Fuses rating gG		10 A * - 500 V
Contact insulation resistance		≤ 25 mΩ
Switching mechanism	type: PL0040..	slow break double gap contacts
Positive operation		NC contact blocks - positive opening
Operating force		4 N
Electric durability AC-15		1 A 1.5 millions of cycles 2 A 0.5 millions of cycles 3 A 0.25 millions of cycles
Terminal type	type: PL0040..	M3.5 screw terminals
Terminal capacity	type: PL0040..	N° 1 or 2 flexible and solid conductor 1 ... 2.5 mm <sup>2</sup>
Climate resistance	IEC68 part 2-3 IEC68 part 2-30	damp heat, steady state damp heat, cyclic

**UL508 characteristics**

Rated insulation voltage [Ui]		10 A - 600 V ac / 2.5 A - 125 V dc
Rated impulse withstand voltage [Uimp]		A600-Q600

\* IMQ approved values

**Available codes**



**PLN05**                      **PLN05D2**                      **PLN05D4**

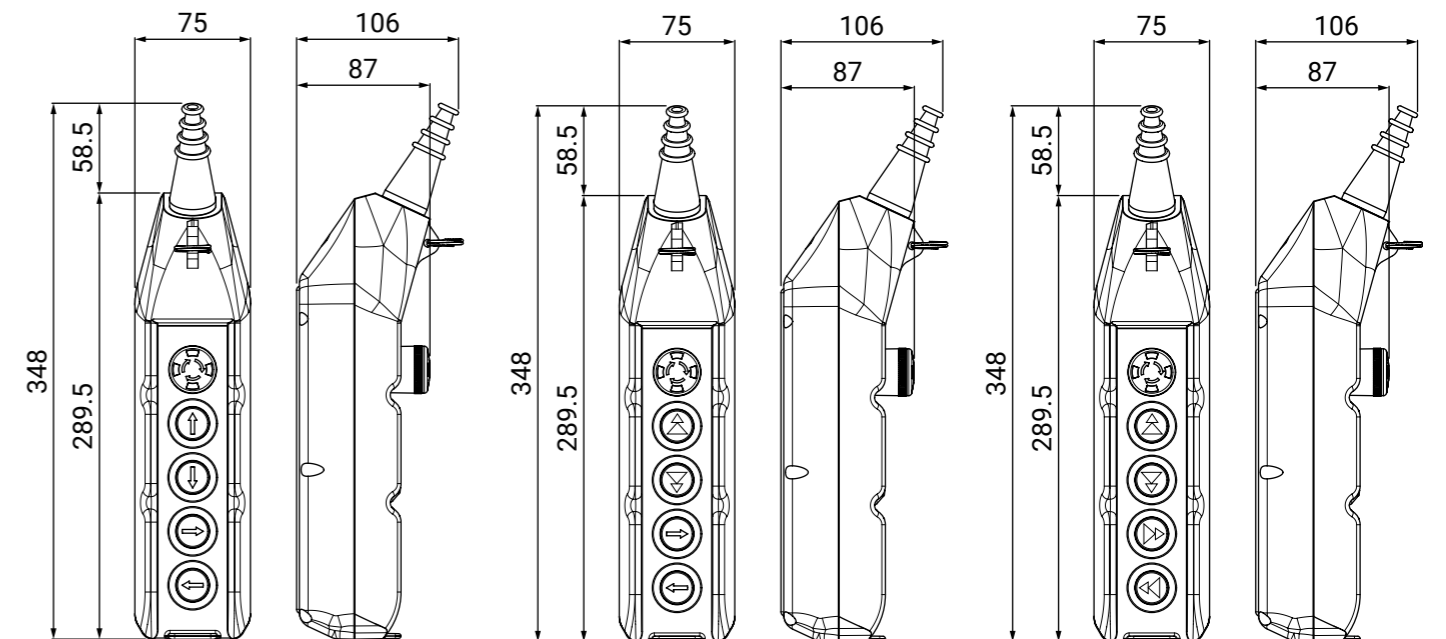

Available codes



**PLN07**



**PLN07D2**

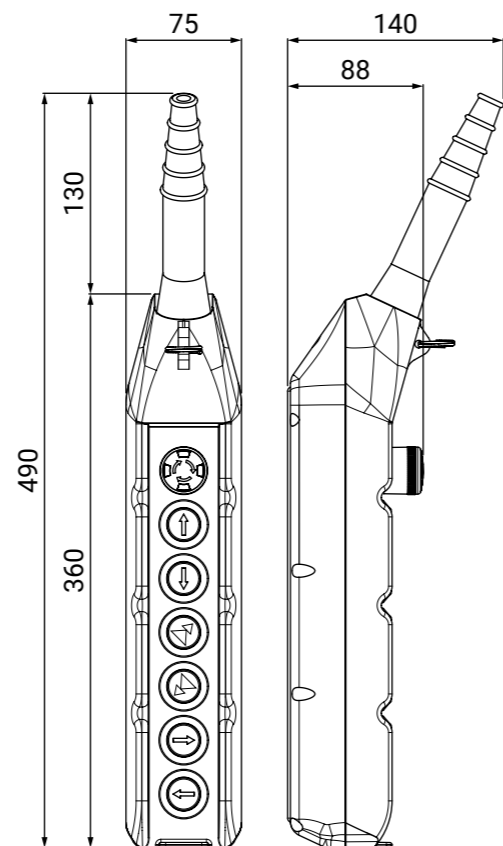
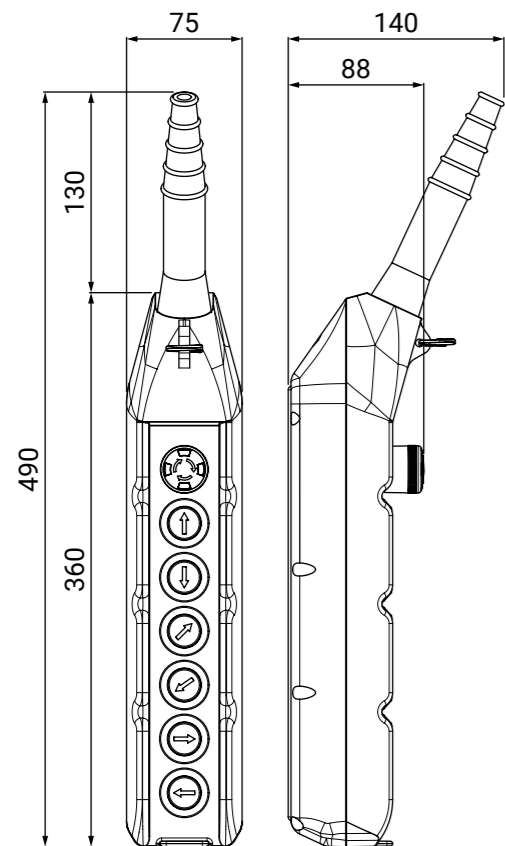

Available codes



**PLN07D4**

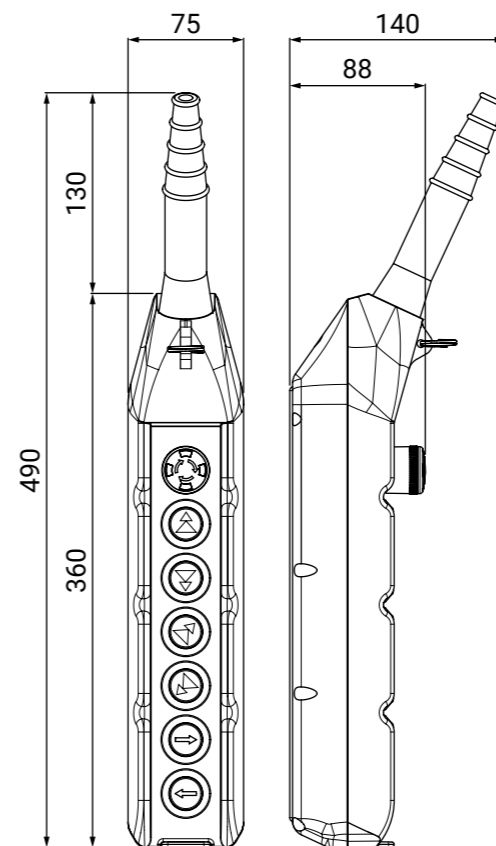

**PLN07D6**

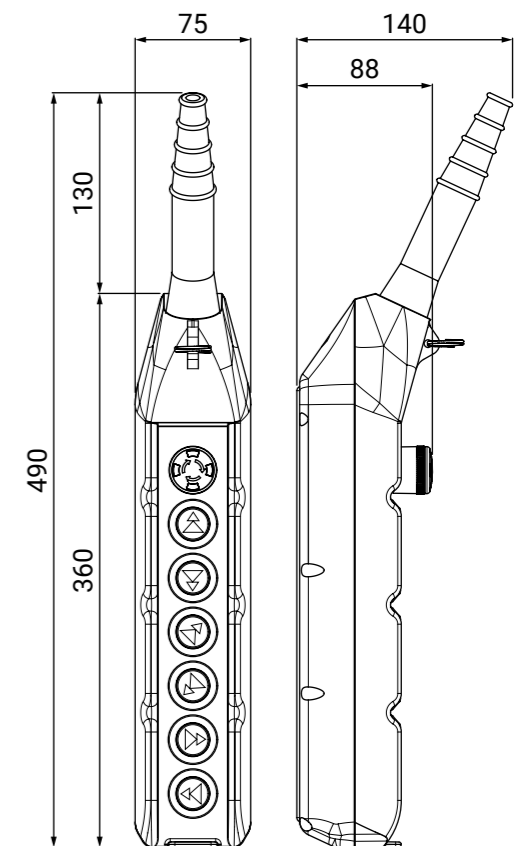

# PLN07

Pendant control station

PENDANT STATIONS

Available codes



**PLN08**

**PLN08D2**

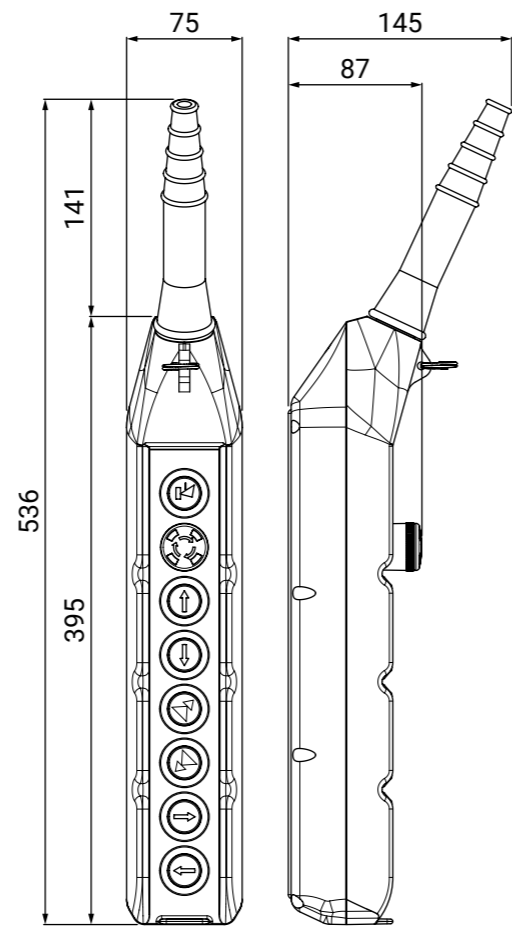
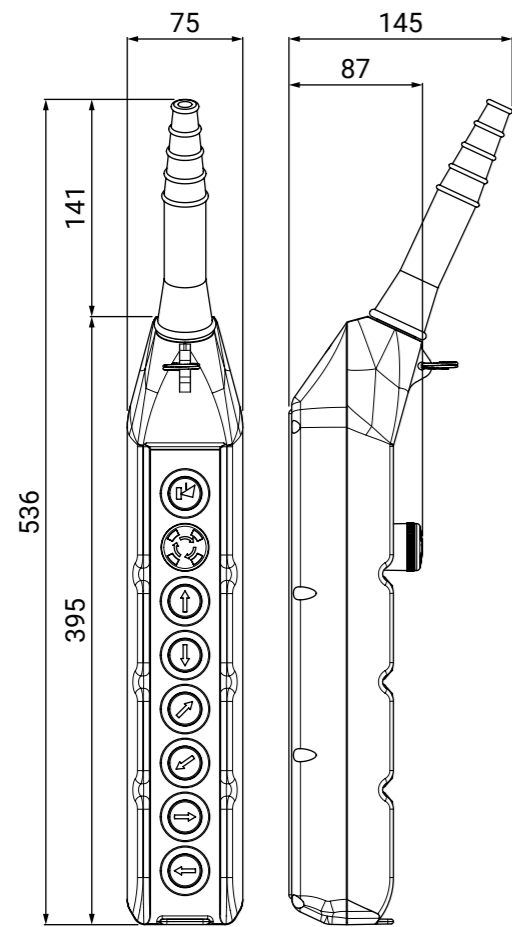

Available codes



**PLN08D4**

**PLN08D6**

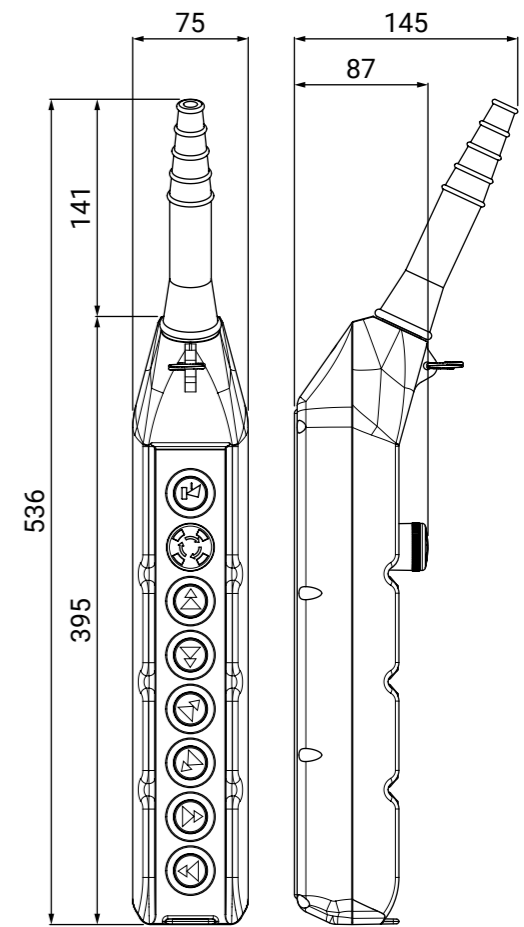
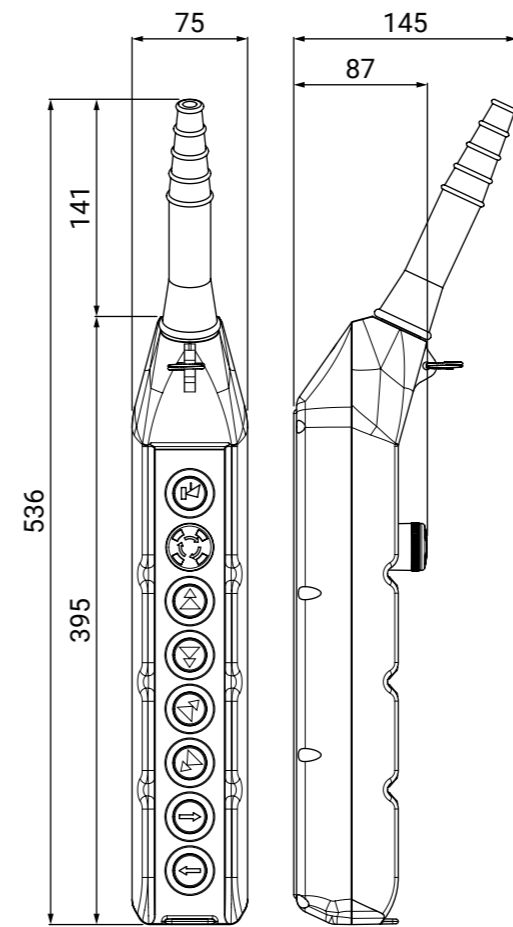

Available codes

# PLN10

Pendant control station

Available codes



**PLN10**

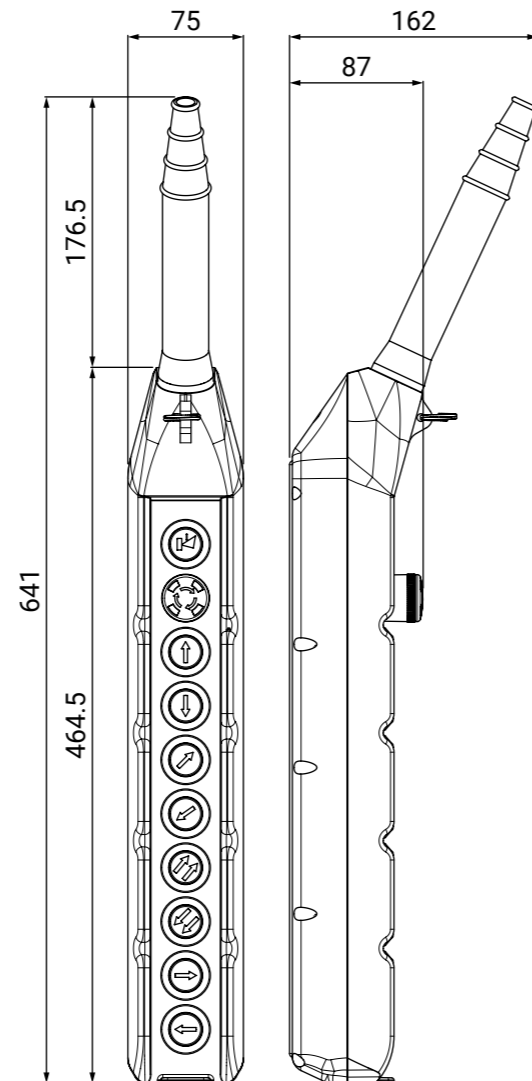

# PLN12

Pendant control station

PENDANT STATIONS



**PLN12**

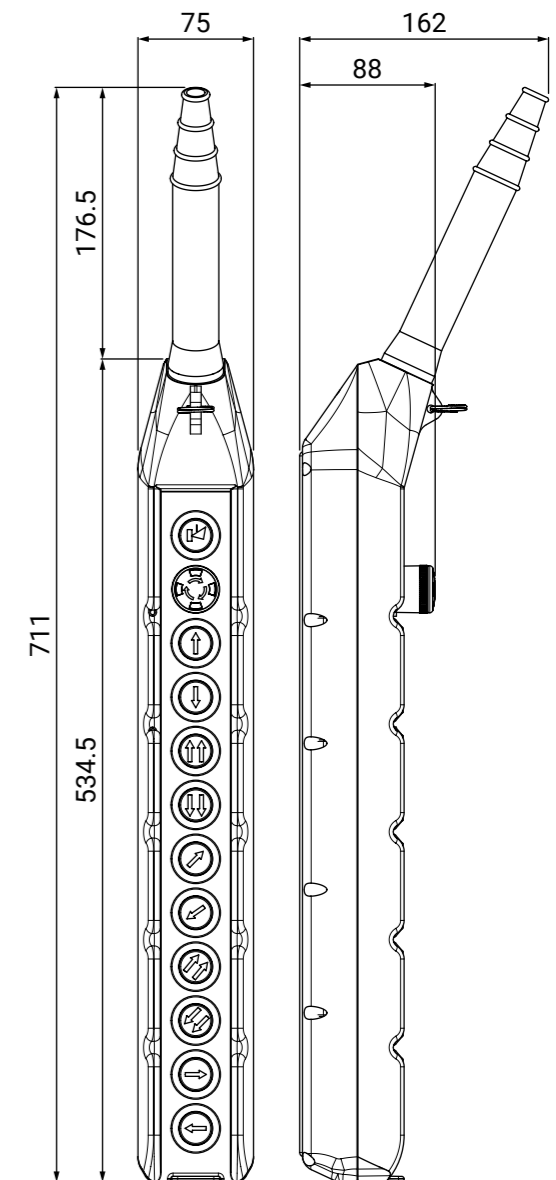



# PLN SERIES

## Pendant control stations

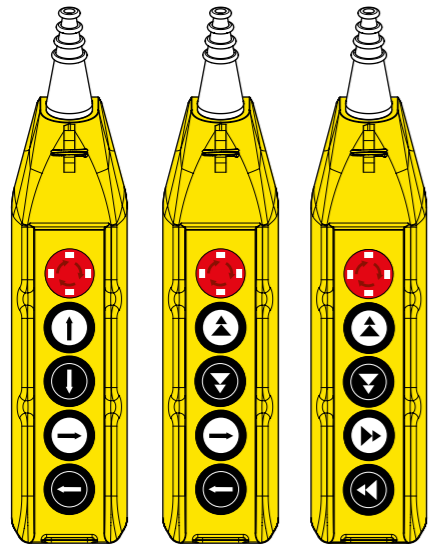

PLN05

PLN05D2

PLN05D4

5

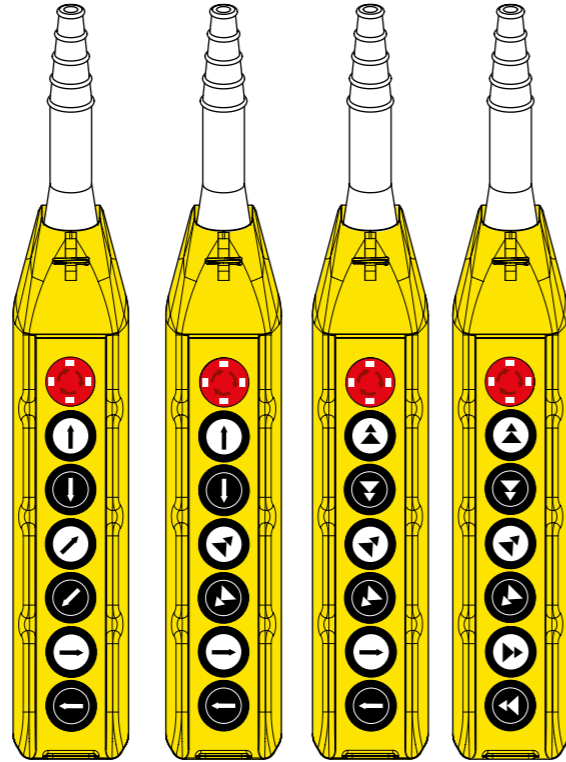

PLN07

PLN07D2

PLN07D4

PLN07D6

7

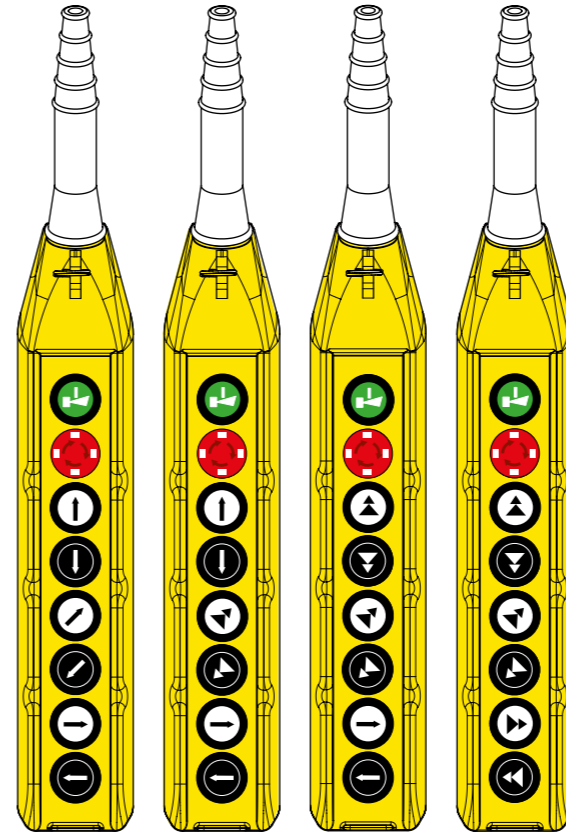

PLN08

PLN08D2

PLN08D4

PLN08D6

8

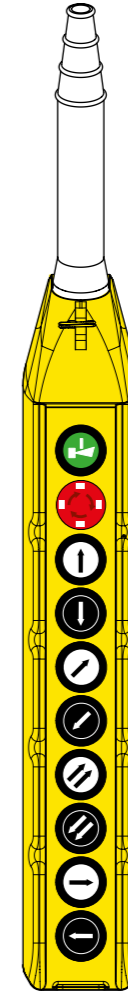

PLN10

10

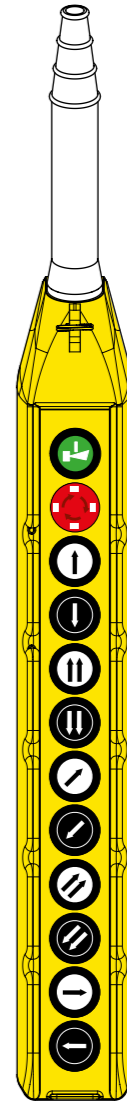

PLN12

12

### CONTACT CONFIGURATION

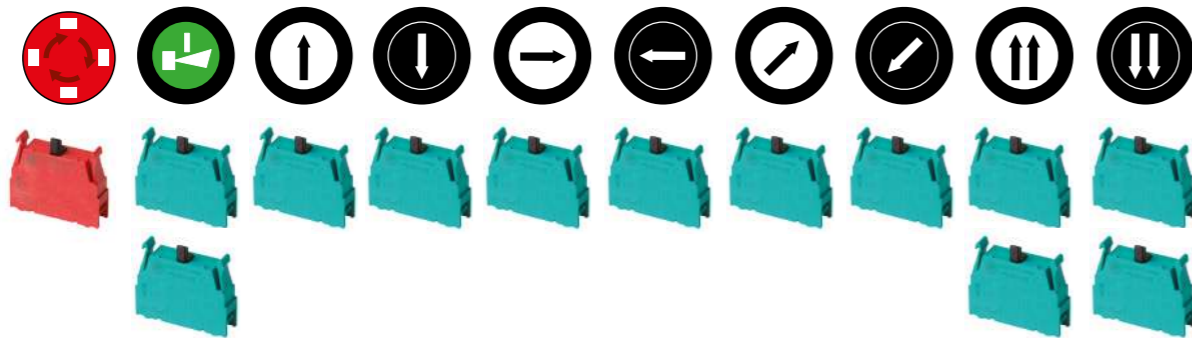

1 NC

2 NO

1 NO

1 NO

1 NO

1 NO

1 NO

1 NO

2 NO

2 NO

### CONTACT CONFIGURATION

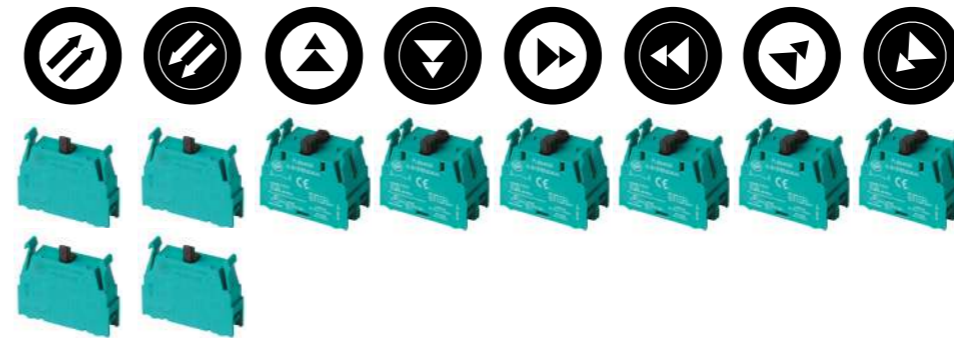

2 NO

2 NO

NO+NO

NO+NO

NO+NO

NO+NO

NO+NO

NO+NO

### CONTACT CODE

#### Single speed



1 NC

PL004001



1 NO

PL004002

#### Double speed



NO + NO

PL004010.S



# TLP

## Wall-mounted control station

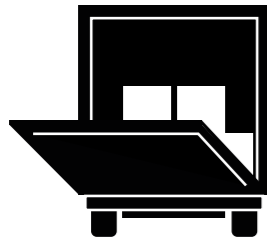

























TRUCK TAIL LIFT

### Single row wall-mounted control station from 1 to 4 push buttons for truck tail lift

#### Features

- Bi-directionality is mechanically interlocked;
- IP65 Double insulation (IEC / EN 60529);
- Laser engraved symbols according to EN 60204-1, FEM 9.941;
- Shock proof and heat resistant;
- Available versions: from 1 to 5 holes;
- Available with UL/CSA requirements;
- Available upon request also in V0 material, UL approved.
- Available in kit version.

#### Available codes

						
TLP1.EPP						
TLP1.ESR						
TLP2						
TLP3.B						
TLP3.D						
TLP4.C						
TLP4.E						







#### Compliance and certifications

- EN 60947-1 (2007/A1 : 2011/A2 : 2014)
- EN 60947-5-1 (2004/A1 : 2009/AC : 2004/AC : 2005)
- EN ISO 13850 (2015)
- EN 60204-1 (2006/A1 : 2009)
- EN-ISO 13849-1 (2015)
- EN ISO 13849-2 (2012)
- EN 60529 (1991/A1 : 2000/A2 : 2013)
- EN 50581 (2012)
- IEC 63000 (2016)
- 2014/35/UE
- 2011/65/UE
- 2015/863/UE

#### Technical data

General characteristics		
Compliant to standards		IEC / EN60947-5-1
Material		PP (Moplen)
Material Group		II
Pollution class		3
Temperature	operating storage	-25°C ... +70°C -30°C ... +70°C
Cable entry		Cable gland M20

#### Electrical characteristics - Contact blocks

Marking		      
Rated insulation voltage [Ui]		690 V *
Rated impulse withstand voltage [Uimp]		4 kV *
Frequency		50/60 Hz *
Rated thermal current [Ith]		16 A *
Rated thermal current in enclosure [Ithe]		10 A
<b>Rated operational current [Ie]</b>		
AC-15 alternate current	type: PCW..	24 V 16 A * 60 V 12 A 110 V 5 A 240 V 5 A * 400 V 4 A 440 V 4 A 500 V 4 A * 690 V 2 A
DC-13 direct current	type: PCW..	24 V 2 A 48 V 2 A * 60 V 1 A * 110 V 0.4 A 250 V 0.4 A *
Conditional short circuit withstand current		1000 A *
Fuses rating gC		10 A * - 500 V
Contact insulation resistance		≤ 25 mΩ
Switching mechanism	type: PCW..	slow break double gap contacts
Positive operation		NC contact blocks - positive opening
Operating force		4 N
Electric durability AC-15		1 A 1.5 millions of cycles 2 A 0.5 millions of cycles 3 A 0.25 millions of cycles
Terminal type	type: PCW..	M3.5 screw terminals
Terminal capacity	type: PCW..	N° 1 or 2 flexible and solid conductor 1 ... 2.5 mm²
Climate resistance	IEC68 part 2-3 IEC68 part 2-30	damp heat, steady state damp heat, cyclic

#### UL508 characteristics

Rated insulation voltage [Ui]		10 A - 600 V ac / 2.5 A - 125 V dc
Rated impulse withstand voltage [Uimp]		A600-Q600

\* IMQ approved values

Available codes



TLP1.EPP



TLP1.ESR



TLP2

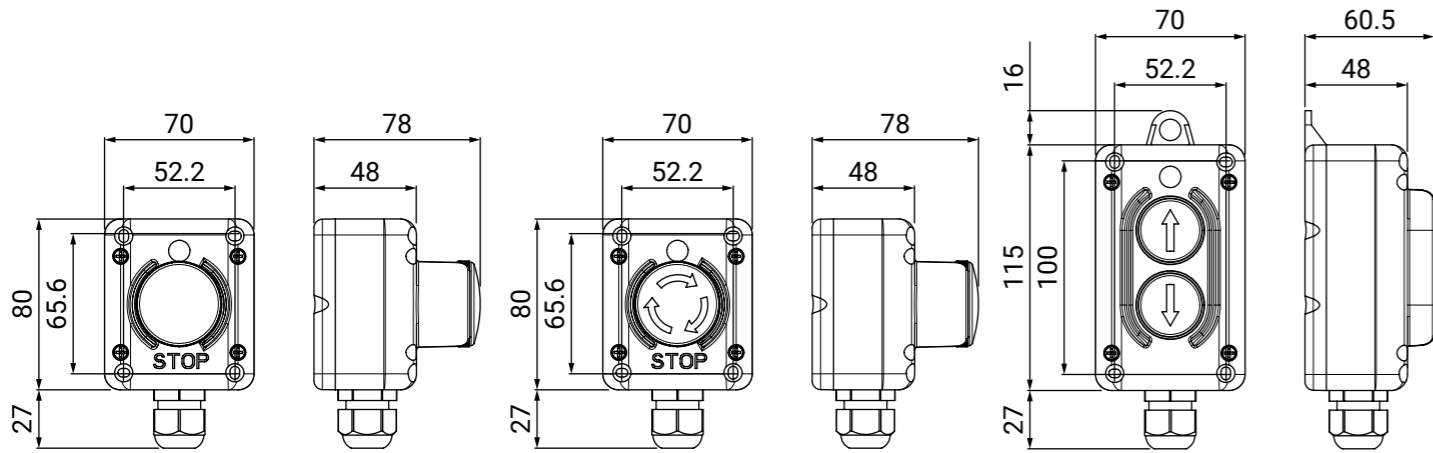

Available codes



TLP3.B



TLP3.D

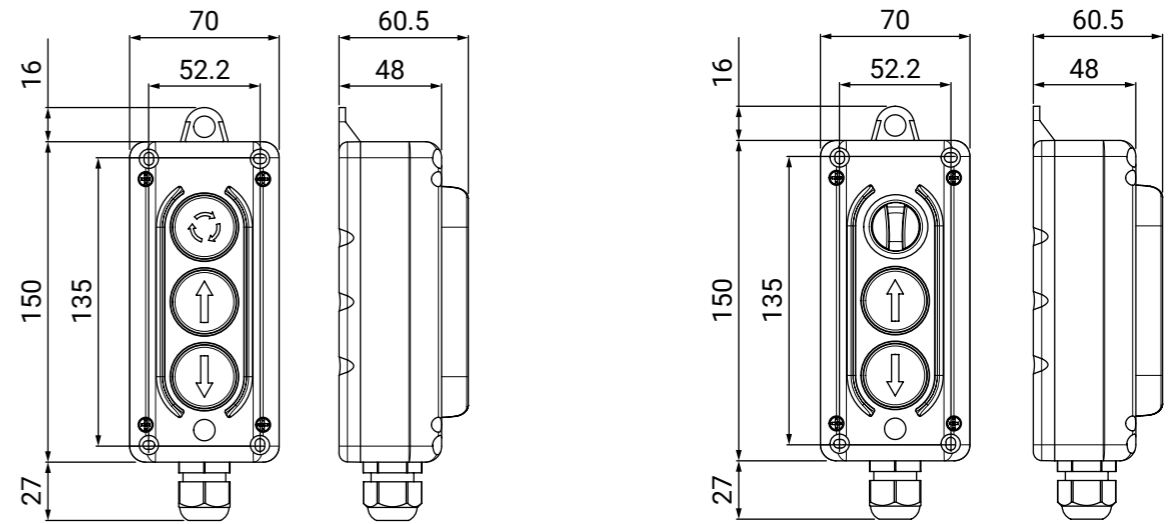

**TLP**  
Wall-mounted control station

PENDANT  
STATIONS

# TLP

## Wall-mounted control station

Available codes



**TLP4.C**



**TLP4.E**

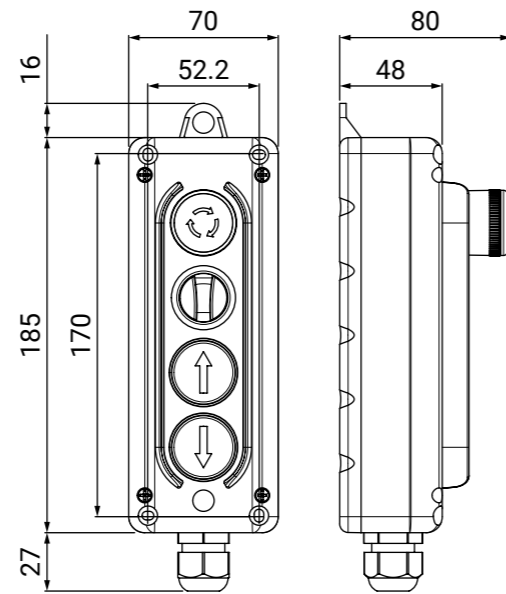
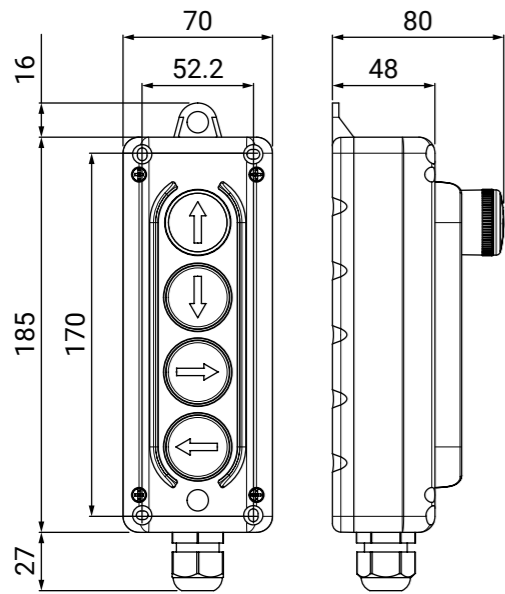

Standard versions

PRODUCT CODE	LAYOUT	PUSH BUTTON	CONTACT CONFIGURATION
<b>TLP1.EPP</b>			1 NC
<b>TLP1.ESR</b>			1 NC
<b>TLP2</b>			1 NO
			1 NO
<b>TLP3.B</b>			1 NC
			1 NO
			1 NO
<b>TLP3.D</b>			1 NO
			1 NO
			1 NO
<b>TLP4.C</b>			1 NO
			1 NO
			1 NO
			1 NO
<b>TLP4.E</b>			1 NC
			1 NO
			1 NO
			1 NO

**CONTACT CODE**

Single speed	
	1 NC
<b>PCW01</b>	
	1 NO
<b>PCW10</b>	

# CUSTOM KITS

## Pendant station and wall-mounted control stations

Giovenzana International B.V., leader in the field of handling system, produces a wide range of pendant control stations able to satisfy the most varied requirements. This range of products is also available in **fully custom kits**.

COMPOSE YOUR OWN CUSTOM KIT IN 3 EASY STEPS:

### STEP 01

Choose the **pendant station type** as to page 56.



**P02K** - Single row pendant station with two holes for small hoist + assembly components

**P03K** - Single row pendant station with three holes for small hoist + assembly components

**PL05K** - Single row pendant station with five holes for crane + assembly components

**PL07K** - Single row pendant station with seven holes for crane + assembly components

**PL08K** - Single row pendant station with eight holes for crane + assembly components

**PL10K** - Single row pendant station with ten holes for crane + assembly components

**PL12K** - Single row pendant station with twelve holes for crane + assembly components

**PLB04K** - Double row pendant station with four holes for crane + assembly components

**PLB06K** - Double row pendant station with six holes for crane + assembly components

**PLB08K** - Double row pendant station with eight holes for crane + assembly components

**PLB10K** - Double row pendant station with ten holes for crane + assembly components

**PLB12K** - Double row pendant station with twelve holes for crane + assembly components

**PLB14K** - Double row pendant station with fourteen holes for crane + assembly components

**TLP1K** - Single row wall-mounted control station with one hole for truck tail lift + assembly components

**TLP2K** - Single row wall-mounted control station with two holes for truck tail lift + assembly components

**TLP3K** - Single row wall-mounted control station with three holes for truck tail lift + assembly components

**TLP4K** - Single row wall-mounted control station with four holes for truck tail lift + assembly components

**TLP5K** - Single row wall-mounted control station with five holes for truck tail lift + assembly components

### STEP 02

Choose the **laser engraved push buttons** between our three series and **additional components** as to page 58.



### STEP 03

Choose the **contact blocks** as to page 63.



## THREE EASY STEPS TO COMPOSE YOUR OWN CUSTOMIZED COMPLETE DEVICE!

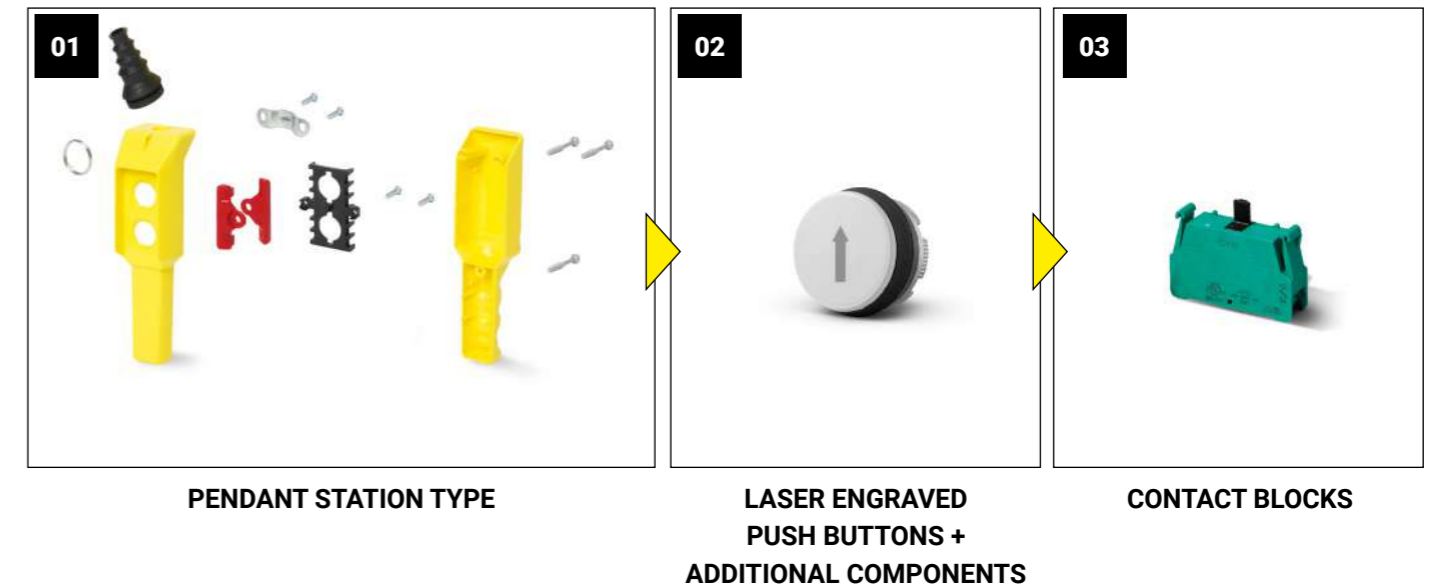

# CUSTOM KIT

## Pendant and wall-mounted

### STEP 01

#### CHOOSE THE PENDANT STATION TYPE

The enclosure kit includes: pendant station base and cover, screws, gasket, cable sleeve and cable clamp, suspension ring, push button interlocks and coupling plates.

The list of detailed components for each type of control station is shown in our instruction manuals downloadable on our website [www.giovenzana.com](http://www.giovenzana.com) in the dedicated section of the technical documentation.

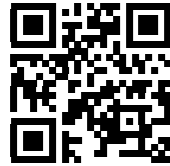

**P02K**  
2 HOLES

**P03K**  
3 HOLES



**PL05K**  
5 HOLES

**PL07K**  
7 HOLES

**PL08K**  
8 HOLES



**PL10K**  
10 HOLES

**PL12K**  
12 HOLES



**PLB04K**  
4 HOLES

**PLB06K**  
6 HOLES

**PLB08K**  
8 HOLES



**PLB10K**  
10 HOLES

**PLB12K**  
12 HOLES

**PLB14K**  
14 HOLES



**TLP1K**  
1 HOLE

**TLP2K**  
2 HOLES



**TLP3K**  
3 HOLES

**TLP4K**  
4 HOLES

**TLP5K**  
5 HOLES

# CUSTOM KIT

## Pendant and wall-mounted

### STEP 02

#### CHOOSE THE LASER ENGRAVED PUSH BUTTONS

Giovenzana International B.V. offers 3 different laser engraved push buttons lines: **PLN**, **PL** and **PL for italian market** (as example of the possibility to engrave different languages on request).

#### FEATURES

- Wide selection of 22 mm or 30 mm operators including push buttons, rotary switches with knob or key command, pilot lights, emergency push buttons and additional components.
- Large variety of colors available.
- Laser engraved symbols are strictly according to FEM 9.941.
- Customized engraving and laser engraved push buttons in other languages are available **on minimum quantity request**.



PLN LINE

New series improved in aesthetic form and ergonomic soft touch



PL LINE

Giovenzana historical laser engraved push buttons series



PL LINE - ITALIAN LASER ENGRAVED

Giovenzana historical italian laser engraved push buttons series (for italian market only). Available the possibility to engrave different languages on minimum quantity request.

#### PLN LINE

#### LASER ENGRAVED PUSH BUTTONS

Pair with the contact block with the matching label **A** to page 63.

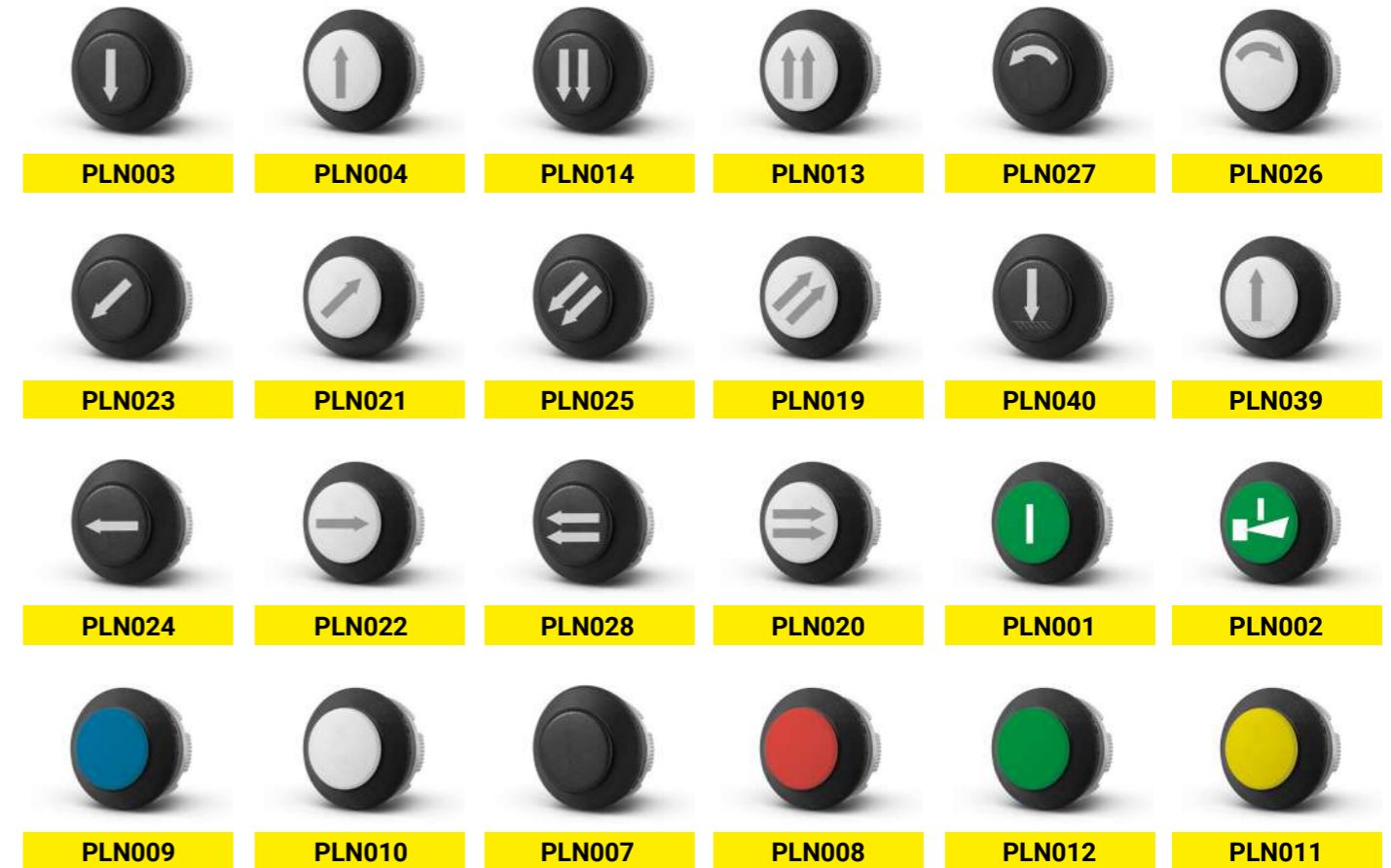

#### DOUBLE SPEED LASER ENGRAVED PUSH BUTTONS

Pair with the contact block with the matching label **C** to page 64.



**PL LINE**

**LASER ENGRAVED PUSH BUTTONS**

Pair with the contact block with the matching label **A** to page 63.

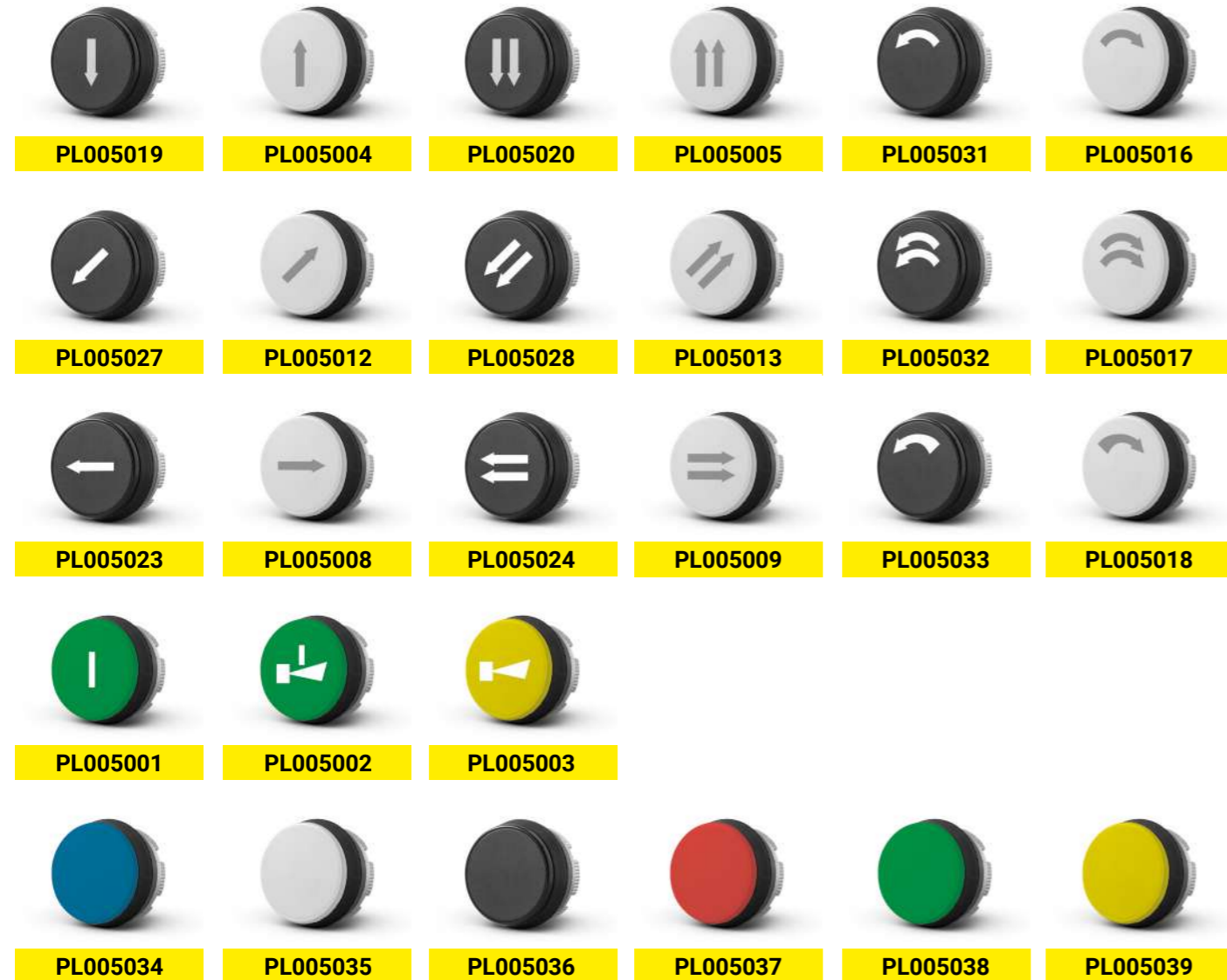

**DOUBLE SPEED LASER ENGRAVED PUSH BUTTONS**

Pair with the contact block with the matching label **C** to page 64.



**PL LINE - ITALIAN LASER ENGRAVED**

**LASER ENGRAVED PUSH BUTTONS**

Pair with the contact block with the matching label **A** to page 63.

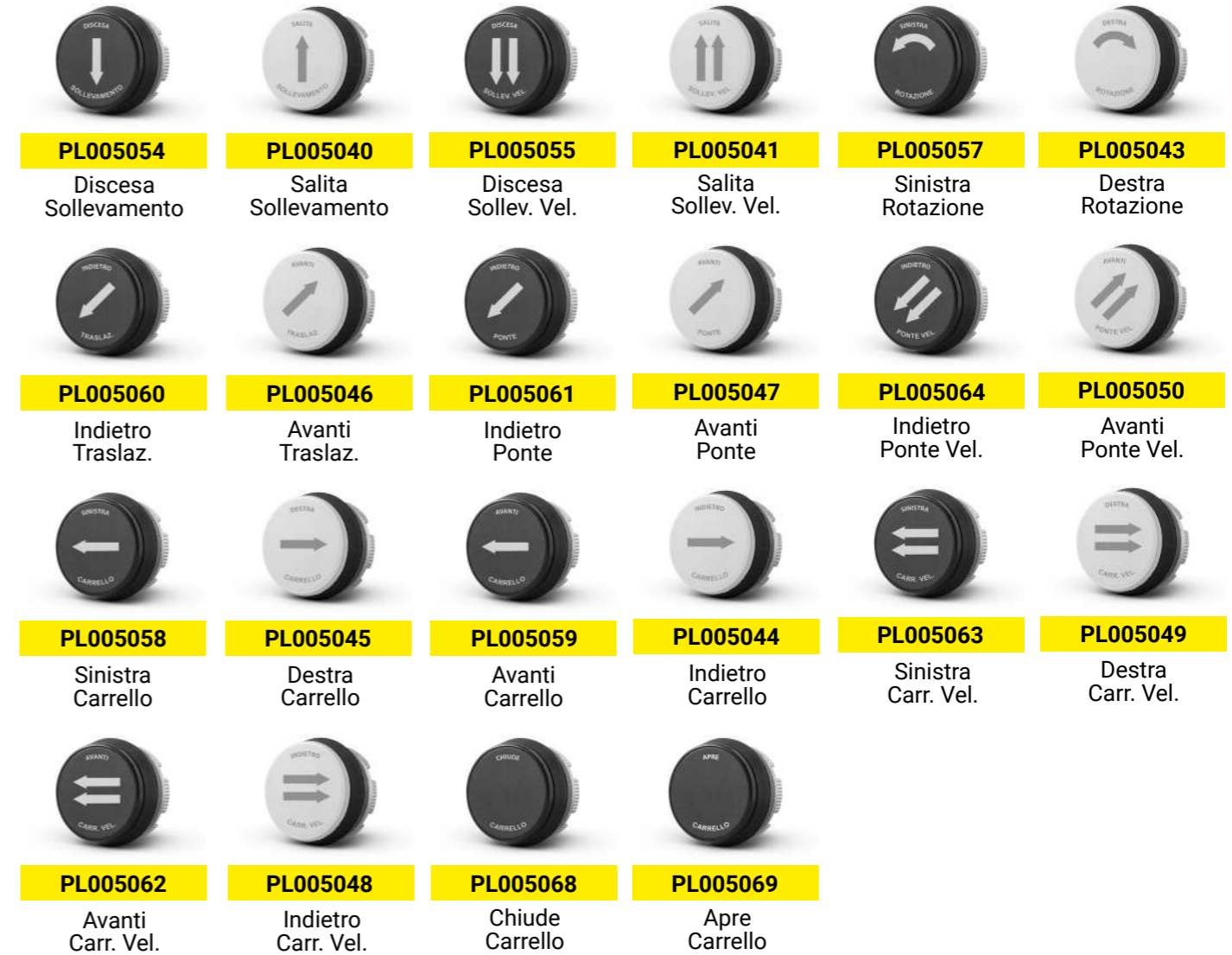

**DOUBLE SPEED LASER ENGRAVED PUSH BUTTONS**

Pair with the contact block with the matching label **C** to page 64.

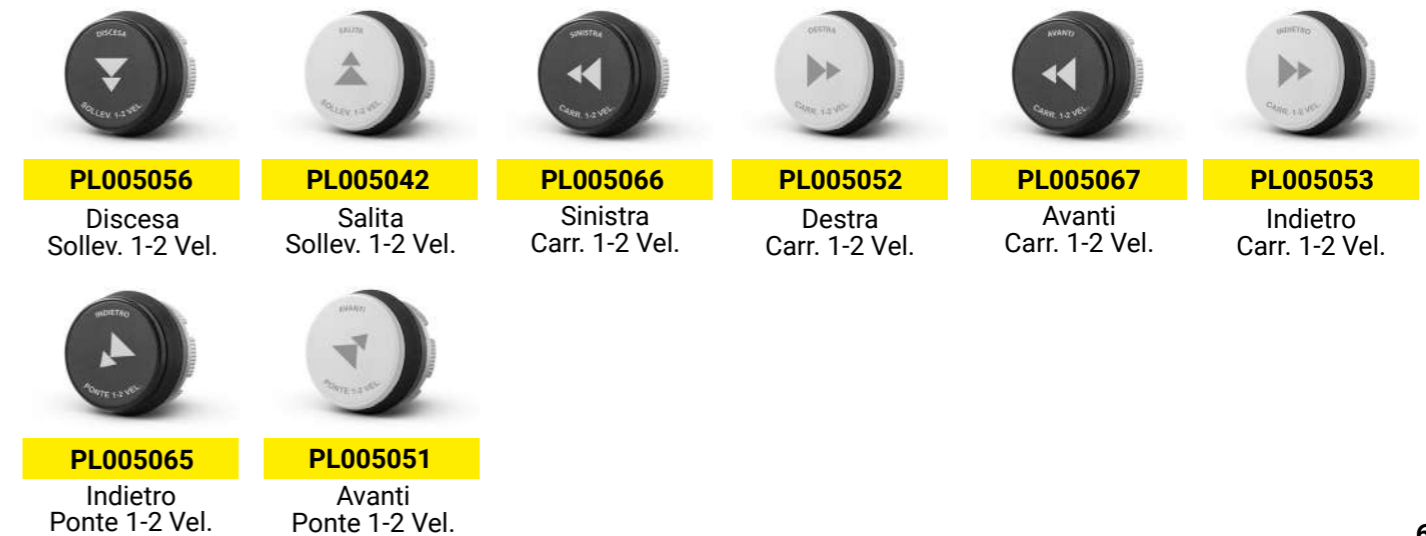

## PILOT LIGHTS

Pair with the contact block with the matching label **B** to page 64.



PLSL1NL

PLSL2NL

PLSL3NL

PLSL4NL

PLSL5NL

## EMERGENCY PUSH BUTTONS

Pair with the contact block with the matching label **A** to page 63.



PL013003BL

Mushroom  
ø40 push-pull  
momentary

PPFN1C4NX

Mushroom  
ø40 with  
key release

PL013001

Mushroom  
ø30 twist to release  
with vision

PL013002

Mushroom  
ø30 twist  
to release

## ROTARY SWITCHES Ø22

Pair with the contact block with the matching label **A** to page 63.



PL007001BL

Rotary switch  
with operator ø22  
0-1 / 90°

PL007002BL

Rotary switch  
with operator ø22  
1-0-2 / 45°

PL007003BL

Rotary switch  
with operator ø22  
1>0<2 / 45°

PL006001BL

Rotary switch  
with removable  
key ø22,  
0-1 / 90°

PL006002BL

Rotary switch  
with removable  
key ø22,  
1-0-2 / 45°

PL006004BL

Rotary switch  
with removable  
key ø22,  
1>0<2 / 45°

## ADDITIONAL COMPONENTS



PL015001

Hole plug



PCF

Operators' fixing  
key

## STEP 03

## PAIR THE RIGHT CONTACT BLOCKS

### CONTACT BLOCKS

- Giovenzana contact blocks offer the flexibility to operate multiple control circuits from a single pilot device.
- They are color coded for instant circuit identification to minimize wiring errors and to expedite the wiring process.
- The customers can combine contact block types to achieve his needed function.

The last step to complete your custom kit is to choose the right contact block.

Identify the type of contact to be associated to the selected operators following the indications.

### SINGLE SPEED CONTACT BLOCKS

Pair with the laser engraved push buttons with the matching label **A** from page 59 to 61.



PL004001

For P02 / P03 / PL.. / PLB.. series

PL004002

PL004001CD

For P02 / P03 series

PL004002CD

PCW01

For HP.. / TLP.. series

PCW10

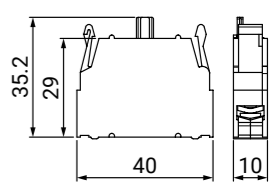
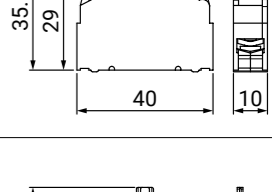
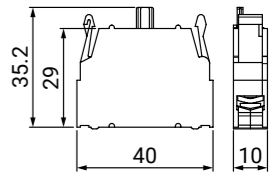
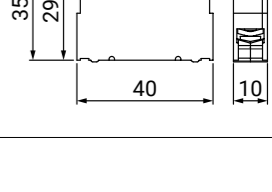
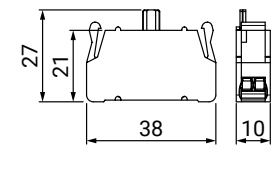
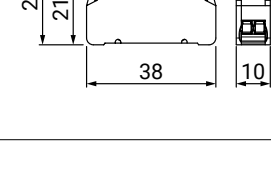
CODE	DESCRIPTION	DESIGNATION	FUNCTION	SIZES
PL004001	NC contact block Screw terminals Single speed	1 — NC — 2	0 1,5 6 mm	
PL004002	NO contact block Screw terminals Single speed	3 — NO — 4	0 3,5 6 mm	
PL004001CD	NC - Screw terminals Single speed Direct Control	1 — NC — 2	0 1,5 6 mm	
PL004002CD	NO - Screw terminals Single speed Direct Control	3 — NO — 4	0 3,5 6 mm	
PCW01	NC - Spring loaded terminals Single speed	1 — NC — 2	0 1,5 6 mm	
PCW10	NO - Spring loaded terminals Single speed	3 — NO — 4	0 3,5 6 mm	



### DOUBLE SPEED CONTACT BLOCKS

Pair with the laser engraved push buttons with the matching label **C** from page 59 to 61.



**PL004010.S**

Double step contact block  
NO + NO



**PCWDS**

Double step contact block  
NO + NO

For P02 / P03 / PL / PLB / PLN / PLBN series

For HP / TLP series

CODE	DESCRIPTION	DESIGNATION	SIZES
PL004010.S	NO contact block Screw terminals High plunger	3 — NO — 4 1 <sup>st</sup> speed	
	NO contact block Screw terminals Low plunger	3 — NO — 4 2 <sup>nd</sup> speed	
PCWDS	NO contact block Spring loaded terminals High plunger	3 — NO — 4 1 <sup>st</sup> speed	
	NO contact block Spring loaded terminals Low plunger	3 — NO — 4 2 <sup>nd</sup> speed	

### LAMPHOLDER WITH BUILT-IN LED

Pair with the pilot lights with the matching label **B** to page 62.

For P02 / P03 / PL.. / PLB.. series

For HP.. / TLP.. series

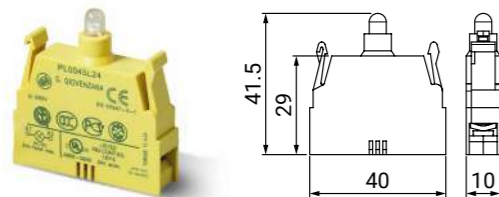

- PL0045L12** AC/DC 12 V
- PL0045L24** AC/DC 24 V
- PL0045L48** AC/DC 48 V
- PL0045L110** AC/DC 110 V
- PL0045L220** AC/DC 220 V

DESIGNATION

X1 — ⊗ — X2

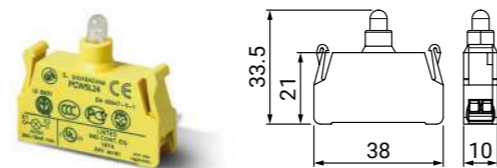

- PCW5L12** AC/DC 12 V
- PCW5L24** AC/DC 24 V
- PCW5L48** AC/DC 48 V
- PCW5L110** AC/DC 110 V
- PCW5L220** AC/DC 220 V

DESIGNATION

X1 — ⊗ — X2

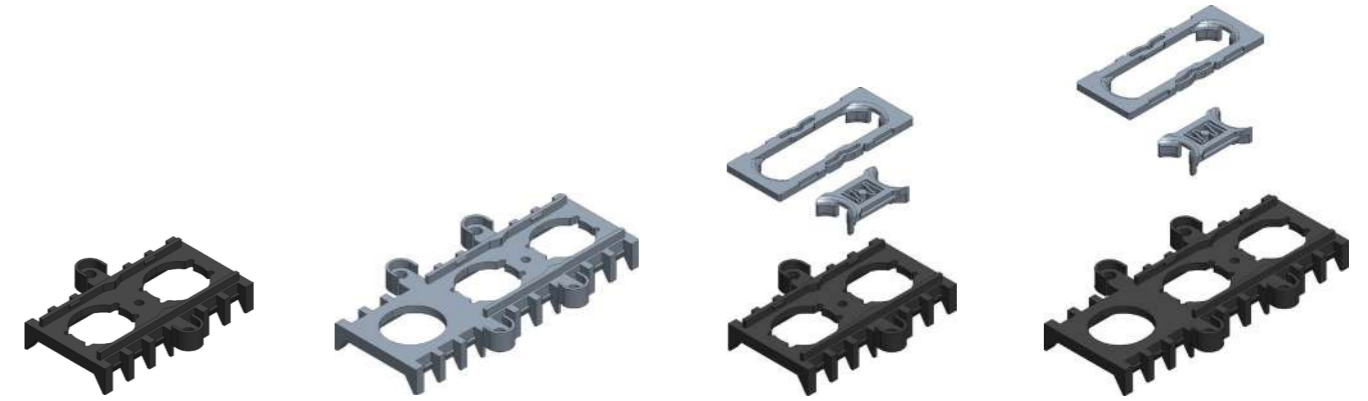

**PL003011**

Coupling plate 2 holes  
for 6 contact blocks

**PL003012**

Coupling plate 3 holes  
for 9 contact blocks

**20100242**

Locking support 2 holes  
for 6 contact blocks

**20100243**

Locking support 3 holes  
for 9 contact blocks



**12906011**

P02 series  
cable gland Ø 7 .. 14



**12906006**

P03 / PL .. 05 series  
cable gland Ø 7 .. 18



**12906004**

PL .. 07 > PL .. 12 series  
PLB .. 04 > PLB .. 06 series  
cable gland Ø 9 .. 21



**12906005**

PLB .. 08 > PLB .. 14 series  
cable gland Ø 12 .. 24



**12901054**

HP03 / TLP.. series  
spiral cable gland M20 x 1.5



**PL012001**

Cable clamp  
lever



**16000061**

Wall bracket  
1 .. 3 holes



**16000062**

Wall bracket  
4 .. 5 holes

# ROTARY GEAR LIMIT SWITCHES

For more than 65 years, **Giovenzana International B.V.** has been designing and producing rotary gear limit switches, offering now four different series.

**Rotary gear limit switches** are used to control the movement of industrial machinery when it's necessary to measure movement based on the rotation angle and/or the number of shaft revolutions, providing upper, lower and/or intermediate limits for moving machinery and mechanisms.

Usually connected to the motor shaft, the rotary gear limit switch uses a series of gears and cams to activate a microswitch when the appropriate number of rotations is reached. This is generally used to stop the motor when a moving load has reached the desired position or final positions.

The device, through a gear transmission, controls a cam system operating on 2, 4 or more microswitches that after a certain number of revolutions predispose the motor or the equipment to the start or stop.

Each cam is equipped with a "micrometric" adjustable register screw that operates in an independent way, so it is possible to calibrate the opening and closing of each microswitch according to the necessary requirements.

The gear transmission system allows to choose different ratios and can be supplied in a bi-protruding shaft version or with linear control (potentiometer or encoder).

Each series of rotary limit switch has specific features which reduce time and costs for installation and maintenance.

Giovenzana International B.V. offers rotary gear limit switches with standard input ratios from 1:12 to 1:400 (custom input ratios are available on request up to 1:3572 - according to the configuration and the typology). They can be configured with maximum 8 contacts and combined with encoders and potentiometers to reach your own needs. We can offer snap action switches and different cam types to meet customers requirements.

The wide range of the input ratios (standards and customized) available in our series, make every customers and applications needs satisfied.

## APPLICATIONS

Giovenzana rotary limit switches are suitable for several applications: from lifting machinery to industrial overhead doors and boat lifts, from theatre lighting hoists to renewable energy systems, like wind turbines.

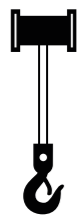

HOIST

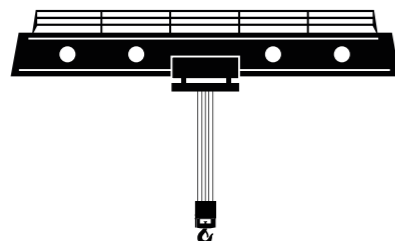

CRANE

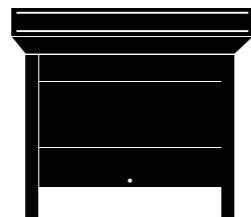

INDUSTRIAL DOORS



WIND TURBINES

## SERIES



FGR0



FGR1



FGR2



FGR3

## FEATURES

- The revolutions of the shaft are transmitted to a cam switch mechanism, through which mechanical switching contacts are actuated.
- Different ratios (also direct ratios) are available for the rotary gear limit switches of the FGR series.
- The switch can be equipped with a maximum of 8 switching contacts.
- Positive opening NC contacts for safety functions.
- Each cam can be individually adjusted to the desired position and thus enables flexible definition of end positions and reference points. More accurate adjustment of cams by means of screws.
- To reduce abrasion and rust, the transmission and guide shafts of the gears are made of stainless steel.
- The circumferential rubber gasket provides great protection against dust and water, allowing IP66 protection to be easily achieved for the entire products range.
- The optimised interior allows quick and easy cabling.

## BENEFITS

- › High protection class degree
- › Extreme temperature resistance: -30°C to +70°C
- › Easy use, resistance and durability
- › Guaranteed safety



**FGR0**

**FGR1**

**FGR2**

**FGR3**

**GENERAL CHARACTERISTICS**

<b>CASE</b>	Self-extinguishing thermoplastic material	Thermoplastic glass fiber reinforced material
<b>PROTECTION CLASS</b>	IP67 - IEC / EN 60529	IP65 - IEC / EN 60529
<b>RATIO</b>	1:12, 1:25, 1:33, 1:50, 1:75, 1:100, 1:150, 1:200, 1:400	1:12, 1:33, 1:50, 1:75, 1:100, 1:150, 1:200, 1:400
<b>DIRECT RATIO</b>	1:25, 1:50	1:50, 1:75, 1:100
<b>SHAFT TYPE</b>	Stainless steel mounted on self-lubricating bush protected by sealing rings on both sides Double overhang shaft version available on request	Stainless steel Double overhang shaft version available on request
<b>FIXING TYPE</b>	Base fixing Front fixing (flanged)	Base fixing Front fixing (flanged)
<b>MICRO SWITCHES</b>	Nr 4 max - micrometric adjustment of roller lever (long life)	Nr 4 max - micrometric adjustment of roller lever (long life)
<b>CAM BLOCK</b>	Self-lubricating with transparent support for easier cam viewing	Self-lubricating with transparent support for easier cam viewing
<b>CABLE ENTRY</b>	M16 (max 2)	M16 or M20 (max 4)
<b>AMBIENTAL TEMPERATURE</b>	Operating: -25°C ... +70°C Storage: -30°C ... +70°C	Operating: -25°C ... +70°C Storage: -30°C ... +70°C

**ELECTRICAL CHARACTERISTICS**

<b>MICRO SWITCHES CONNECTIONS</b>	MFI.3 - 6.3 x 0.8 faston terminal MFI.3STP - Screws M3 for wire 1.5 mm <sup>2</sup> with plate protection	MFI.7 - 6.3 x 0.8 faston terminal
<b>STANDARD CONFORMITY</b>	IEC / EN 61058-1, UL 1054, EN 60204-1, EN 60947-1, EN 60947-5-1	IEC / EN 61058-1, UL 1054, EN 60204-1, EN 60947-1, EN 60947-5-1
<b>MARKING</b>	CE, cRUus, CCC, EAC	CE, cRUus, CCC, EAC
<b>RATED INSULATION VOLTAGE - U<sub>i</sub></b>	250V	250V
<b>RATED THERMAL CURRENT - I<sub>th</sub></b>	8A	8A
<b>RATED OPERATING CURRENT</b>	Resistive Load: 8A - 250 V AC Inductive Load: 3A - 250 V AC	8A - 250 V AC 3A - 250 V AC
<b>RATED IMPULSE WITHSTAND VOLTAGE - U<sub>imp</sub></b>	1500 V	1500 V
<b>POSITIVE OPENING</b>	NC positive opening (→)	NC positive opening (→)
<b>CONTACT BLOCKS</b>	1NC - 1 NO changeover snap action / silver plated - self cleaning	1NC - 1 NO changeover snap action / silver plated - self cleaning
<b>PROTECTION CLASS</b>	IP40 (IP00 terminals) in according to EN 60529	IP40 (IP00 terminals) in according to EN 60529

**OPTIONS**

<b>DOUBLE OVERHANG SHAFT</b>	Available	Available
<b>POTENTIOMETER</b>	According to customer request	-
<b>ENCODER</b>	-	-
<b>CAM SHAPES</b>	5 different cam shapes	5 different cam shapes
<b>PINIONS</b>	On request	20 different pinion shapes on request

**GENERAL CHARACTERISTICS**

<b>CASE</b>	Aluminium housing / self-extinguishing cover V0 UL94	Thermoplastic glass fiber reinforced material
<b>PROTECTION CLASS</b>	IP65 - IEC / EN 60529	IP66
<b>RATIO</b>	-	From 1:8 to 1:3572 (according to the configuration)
<b>DIRECT RATIO</b>	1:12, 1:33, 1:50, 1:100, 1:200	-
<b>SHAFT TYPE</b>	Steel mounted on ball bearings Double overhang shaft version available on request	AISI 304 Stainless steel mounted on ball bearings Double overhang shaft version available on request
<b>FIXING TYPE</b>	Base fixing Front fixing (flanged)	Base fixing Front fixing (flanged)
<b>MICRO SWITCHES</b>	Nr 6 max - micrometric adjustment of roller lever (long life)	Nr 8 max - micrometric adjustment of roller lever (long life)
<b>CAM BLOCK</b>	Self-lubricating	Self-lubricating with transparent support for easier cam viewing
<b>CABLE ENTRY</b>	M20 (max 2)	M20 (max 3)
<b>AMBIENTAL TEMPERATURE</b>	Operating: -25°C ... +70°C Storage: -30°C ... +70°C	Operating: -40°C ... +90°C Storage: -40°C ... +90°C

**ELECTRICAL CHARACTERISTICS**

<b>MICRO SWITCHES CONNECTIONS</b>	MFI.7 - 6.3 x 0.8 faston terminal	MFI.7 - 6.3 x 0.8 faston terminal
<b>STANDARD CONFORMITY</b>	IEC / EN 61058-1, UL 1054, EN 60204-1, EN 60947-1, EN 60947-5-1	IEC / EN 61058-1, UL 1054, EN 60204-1, EN 60947-1, EN 60947-5-1
<b>MARKING</b>	CE, cRUus, CCC, EAC	CE, cRUus, CCC, EAC
<b>RATED INSULATION VOLTAGE - U<sub>i</sub></b>	250V	250V
<b>RATED THERMAL CURRENT - I<sub>th</sub></b>	8A	8A
<b>RATED OPERATING CURRENT</b>	Resistive Load: 8A - 250 V AC Inductive Load: 3A - 250 V AC	8A - 250 V AC 3A - 250 V AC
<b>RATED IMPULSE WITHSTAND VOLTAGE - U<sub>imp</sub></b>	1500 V	1500 V
<b>POSITIVE OPENING</b>	NC positive opening (→)	NC positive opening (→)
<b>CONTACT BLOCKS</b>	1NC - 1 NO changeover snap action / silver plated - self cleaning	1NC - 1 NO changeover snap action / silver plated - self cleaning
<b>PROTECTION CLASS</b>	IP40 (IP00 terminals) in according to EN 60529	IP40 (IP00 terminals) in according to EN 60529

**OPTIONS**

<b>DOUBLE OVERHANG SHAFT</b>	Available	Available
<b>POTENTIOMETER</b>	-	According to customer request
<b>ENCODER</b>	-	According to customer request
<b>CAM SHAPES</b>	3 different cam shapes	5 different cam shapes
<b>PINIONS</b>	20 different pinion shapes on request	20 different pinion shapes on request

# FGRO

## Rotary gear limit switch



### Rotary gear limit switch with overall reduced sizes

The **FGRO** is a device for controlling revolutions of rotating components or the angular position of industrial or construction machinery. A typical application is for small cranes. Also suitable for different applications such as automatic doors or automatic roofs in greenhouses. The unit, through a system of gears and cams transmission, controls 2 or 4 microswitches so, after a certain number of revolutions, predispose the motor or the equipment to the start or stop operation.

The microswitches have a calibration screw that works independently on each cam; so you can calibrate the opening and closing of each micro according to the necessary functional requirements.

The system change allows you to choose different ratios from 1:12 to 1:1480.

### General features

- Different versions available:
  - base fixing;
  - front fixing (with standard flange);
  - with double overhang shaft (on request).
- Overall size is reduced.
- Two different cover heights depending on whether the device is equipped with 2 or 4 microswitches.
- IP67 protection class (IEC / EN 60529).
- Available in different ratios: 1:12, 1:25, 1:33, 1:50, 1:75, 1:100, 1:150, 1:200, 1:400 (optional on request).
- Available in direct ratio: 1:25, 1:50 (others direct ratio on request).
- Available on request with pinions.
- Micro switches:
  - device available with 2 or 4 microswitches;
  - the working point is adjustable with a calibration screw;
  - each switch has 1NO + 1NC inside;
  - positive opening for NC contacts.

### Compliance and certifications

- 2014/35/UE - 2014/33/UE - 2011/65/UE - 2015/863/UE
- EN 60947-1 (2007/A1 : 2011/A2 : 2014)
- EN 60947-5-1 (2004/A1 : 2009/AC : 2004/AC : 2005)
- EN 60204-1 (2006/A1 : 2009)
- EN 60529 (1991/A1 : 2000/A2 : 2013)
- EN 50581 (2012)
- IEC 63000 (2016)

### Base Fixing versions

X-ray views



2 microswitches



4 microswitches



2 microswitches  
Direct Ratio



4 microswitches  
Direct Ratio

### Available codes

**FGRO**  
Internal cam pack  
2 microswitches



MFI.3

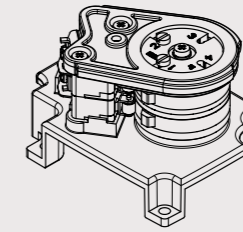

**FGRO**  
Internal cam pack  
4 microswitches



MFI.3

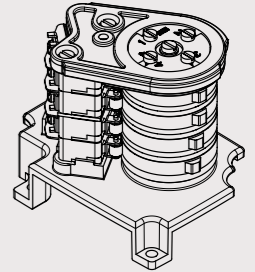

Base fixing  
2 microswitches

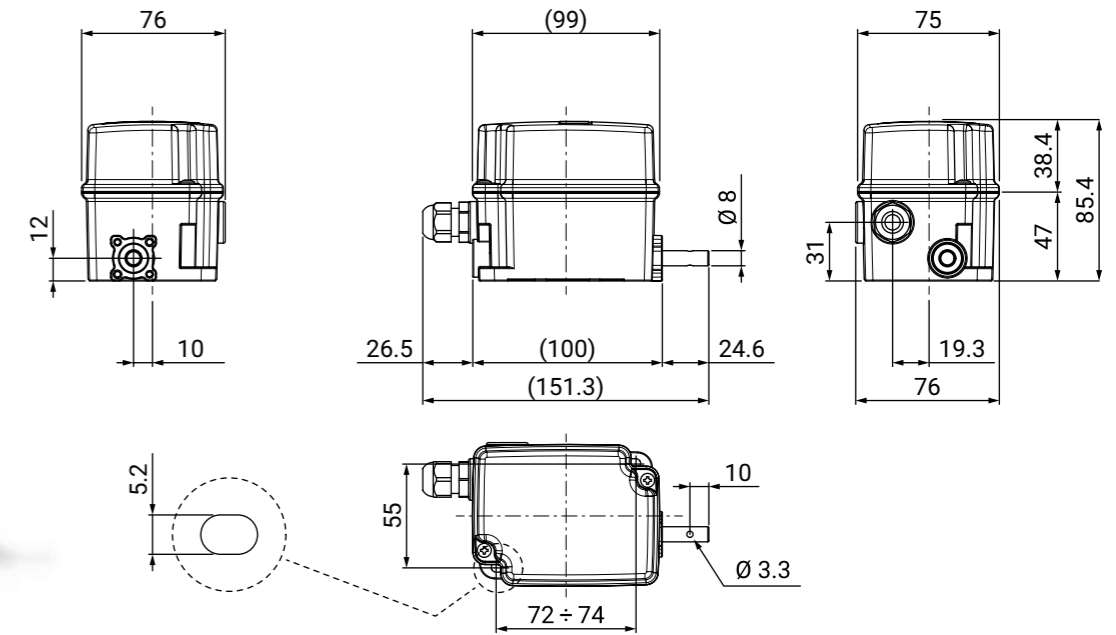

Base fixing  
4 microswitches

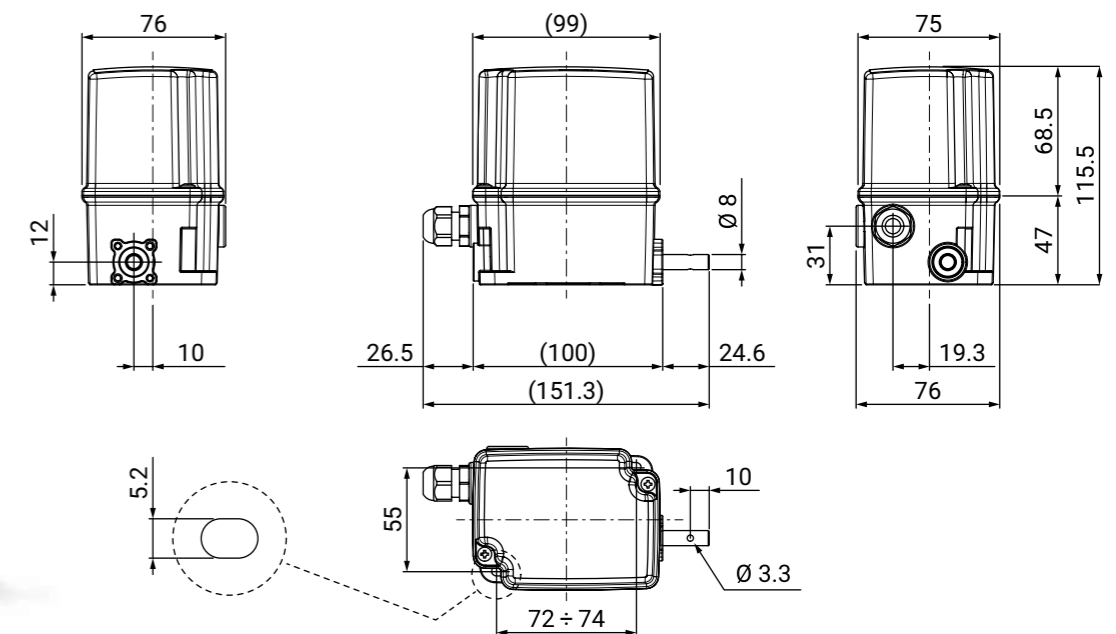

Available codes



**Front fixing**  
2 microswitches

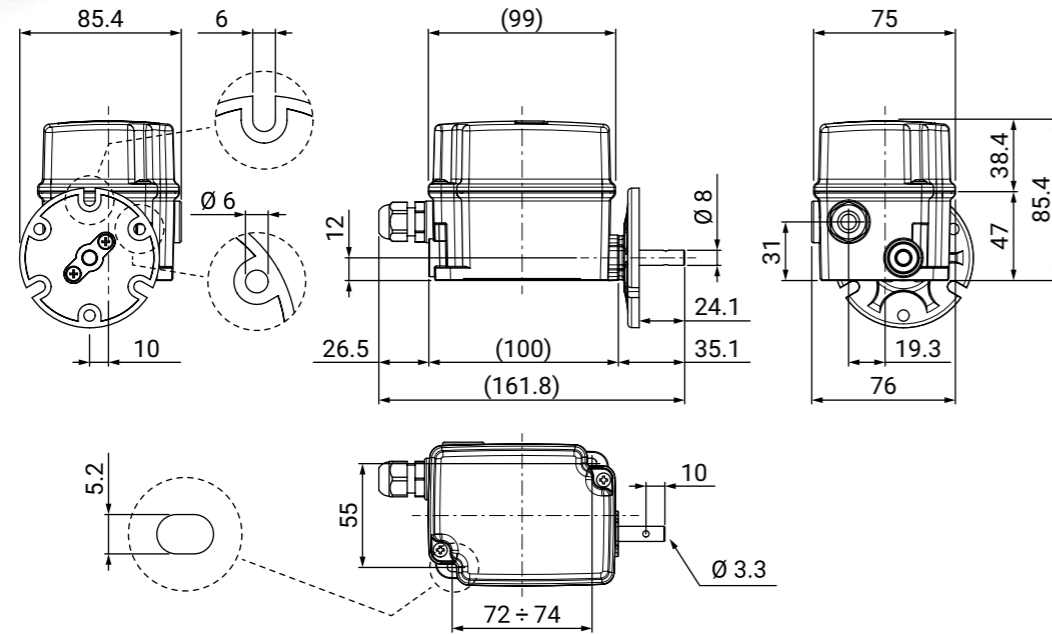

Available codes



**Double overhang shaft**  
2 microswitches

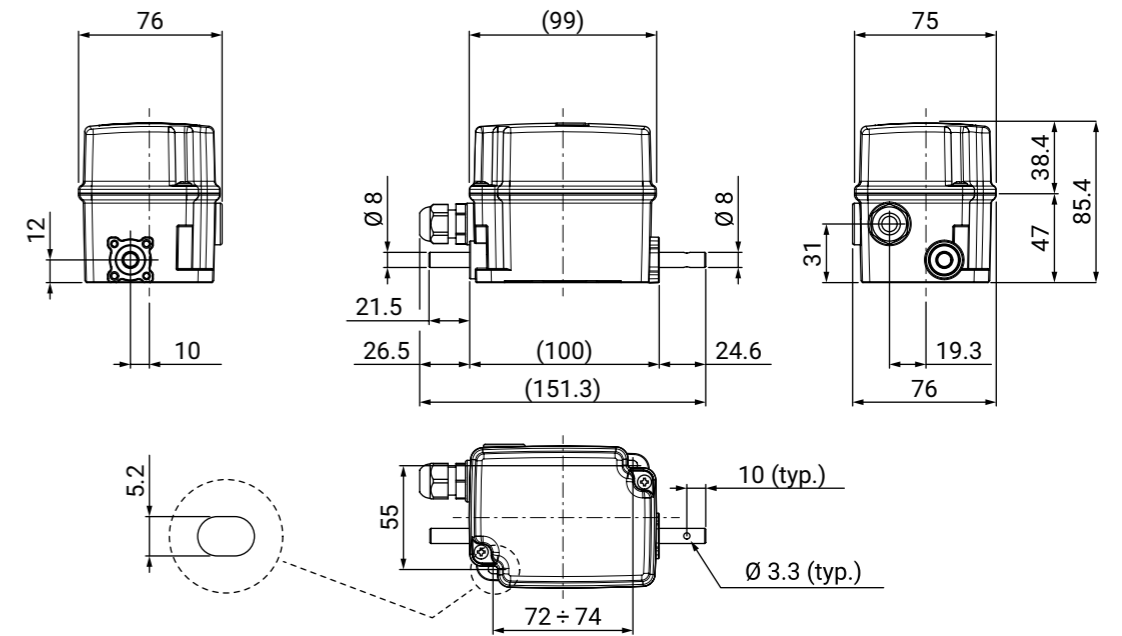

**Front fixing**  
4 microswitches

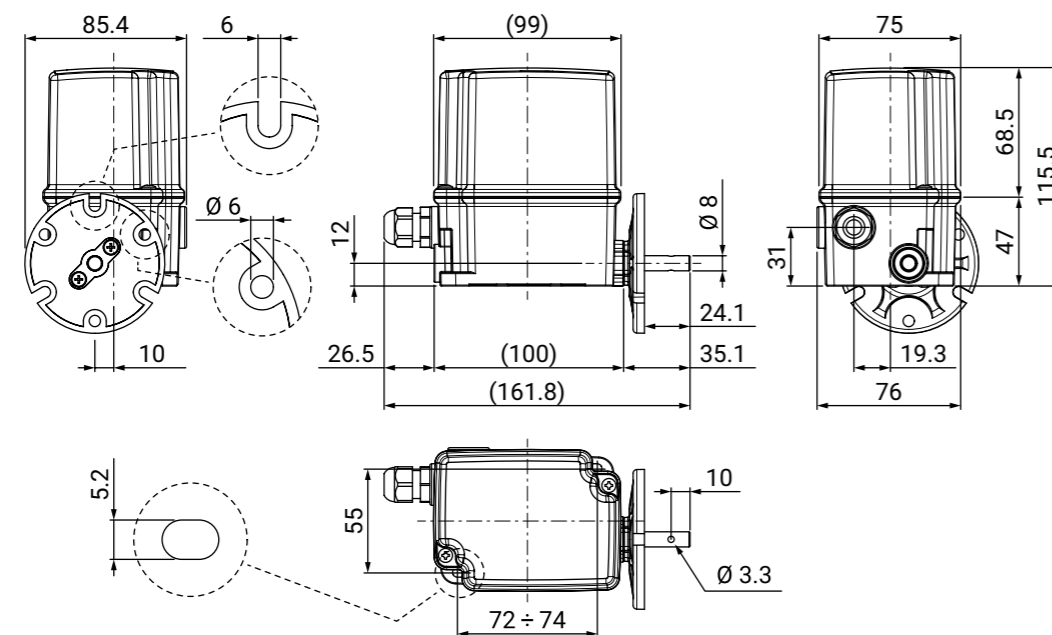

**Double overhang shaft**  
4 microswitches

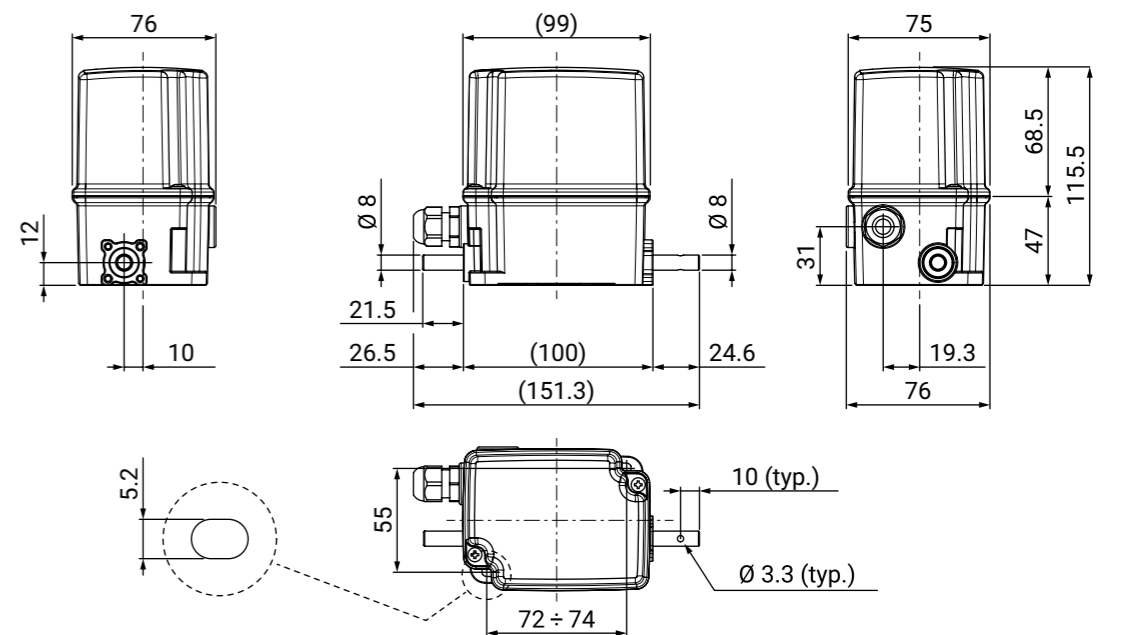

### Coding system

The **FGR0** coding system is very clear: each block of digits identifies a specific function. The code provides all the informations that can be used to specify each customization.

FGR0	-	0012	M	F	-	4	A	-	E1	-	01
Series	-	Nr. gear ratio	Shaft type	Flange	-	Nr. contacts	Contacts type	-	Options	-	Progressive versions
			M = single shaft B = double overhang shaft				A = MFI.3 (standard) B = MFI.3STP (on request)		E = Encoder P = Potentiometer		Not standard shaft, cams, pinions, colors, logos, extra accessories, etc...
STANDARD ENCODING							OPTIONAL ENCODING				

### Available codes

**Base fixing**  
2 microswitches



- FGR0-0012M-2A
- FGR0-0025M-2A
- FGR0-0033M-2A
- FGR0-0050M-2A
- FGR0-0075M-2A
- FGR0-0100M-2A
- FGR0-0150M-2A
- FGR0-0200M-2A
- FGR0-0400M-2A

**Base fixing**  
4 microswitches



- FGR0-0012M-4A
- FGR0-0025M-4A
- FGR0-0033M-4A
- FGR0-0050M-4A
- FGR0-0075M-4A
- FGR0-0100M-4A
- FGR0-0150M-4A
- FGR0-0200M-4A
- FGR0-0400M-4A

**Double overhang shaft**  
2 microswitches



- FGR0-0012B-2A
- FGR0-0025B-2A
- FGR0-0033B-2A
- FGR0-0050B-2A
- FGR0-0075B-2A
- FGR0-0100B-2A
- FGR0-0150B-2A
- FGR0-0200B-2A
- FGR0-0400B-2A

**Double overhang shaft**  
4 microswitches



- FGR0-0012B-4A
- FGR0-0025B-4A
- FGR0-0033B-4A
- FGR0-0050B-4A
- FGR0-0075B-4A
- FGR0-0100B-4A
- FGR0-0150B-4A
- FGR0-0200B-4A
- FGR0-0400B-4A

**Front fixing**  
2 microswitches



- FGR0-0012MF-2A
- FGR0-0025MF-2A
- FGR0-0033MF-2A
- FGR0-0050MF-2A
- FGR0-0075MF-2A
- FGR0-0100MF-2A
- FGR0-0150MF-2A
- FGR0-0200MF-2A
- FGR0-0400MF-2A

**Front fixing**  
4 microswitches



- FGR0-0012MF-4A
- FGR0-0025MF-4A
- FGR0-0033MF-4A
- FGR0-0050MF-4A
- FGR0-0075MF-4A
- FGR0-0100MF-4A
- FGR0-0150MF-4A
- FGR0-0200MF-4A
- FGR0-0400MF-4A

#### AVAILABLE CONTACT TYPES



#### AVAILABLE CAM SHAPES

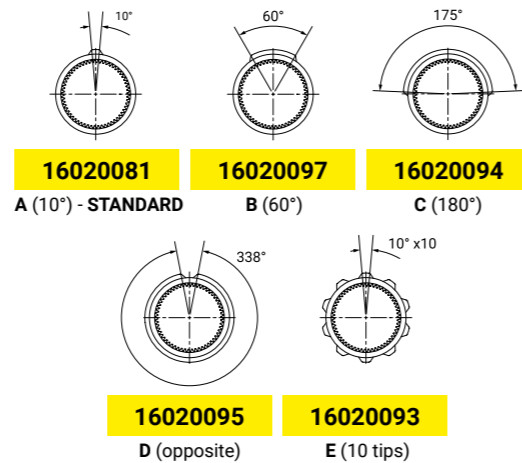

### Rotary gear limit switch

The **FGR1** is a device used to control and measure the movement of industrial machines by measuring the rotation angle and/or counting the number of revolutions of a shaft.

#### General features

- Different versions available:
  - base fixing;
  - front fixing;
  - with double overhang shaft.
- IP65 Protection class.
- Available in different ratios: 1:12, 1:33, 1:50, 1:75, 1:100, 1:150, 1:200, 1:400 (optional on request).
- Available in direct ratio: 1:50, 1:75, 1:100 (others direct ratio on request).
- Available on request with pinions.
- Micro switches:
  - device available with 4 microswitches;
  - the working point is adjustable with a calibration screw;
  - each switch has 1NO + 1NC inside;
  - positive opening for NC contacts.

#### Compliance and certifications

- 2014/35/UE - 2014/33/UE - 2011/65/UE - 2015/863/UE
- EN 60947-1 (2007/A1 : 2011/A2 : 2014)
- EN 60947-5-1 (2004/A1 : 2009/AC : 2004/AC : 2005)
- EN 60204-1 (2006/A1 : 2009)
- EN 60529 (1991/A1 : 2000/A2 : 2013)
- EN 50581 (2012)
- IEC 63000 (2016)

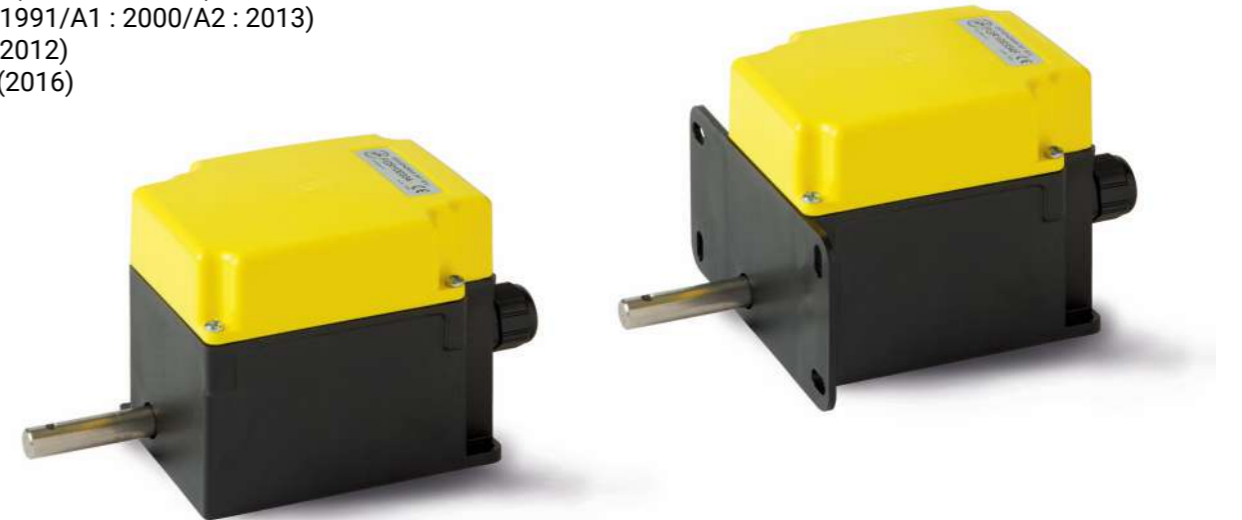

#### Base Fixing versions

X-ray views

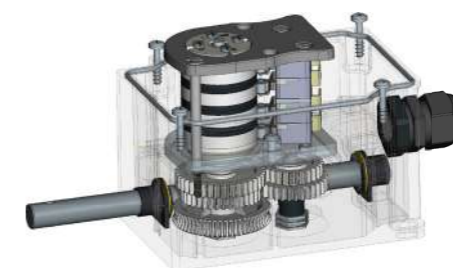

4 microswitches

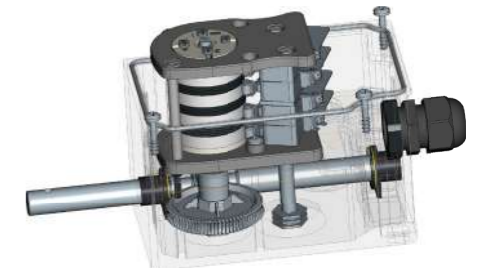

4 microswitches  
Direct Ratio

Available codes

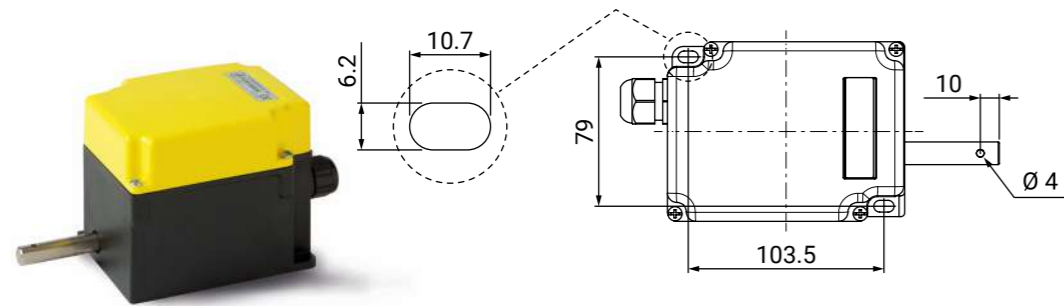
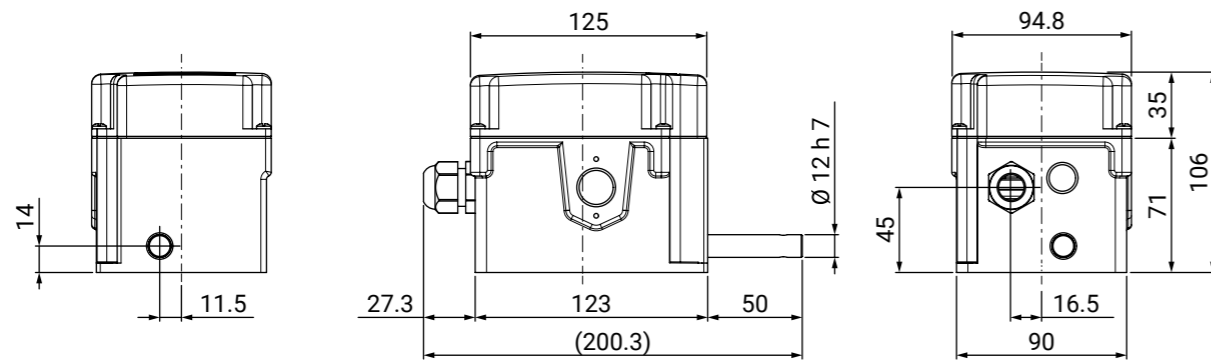
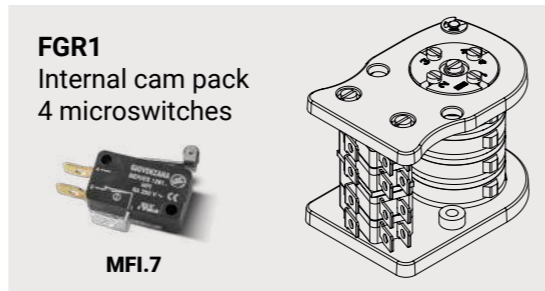

**Base fixing**  
4 microswitches

Available codes

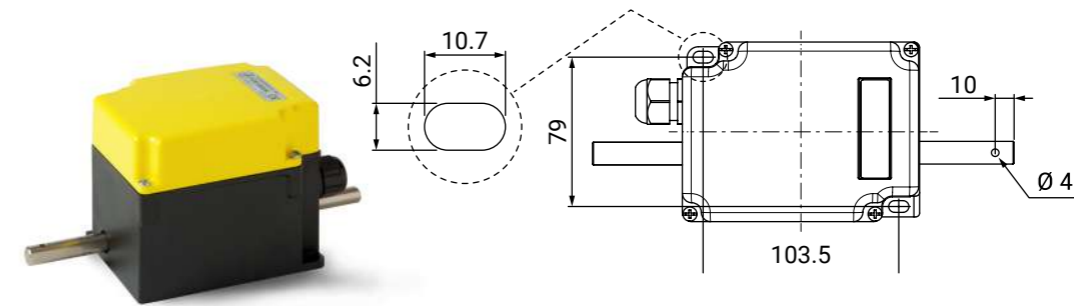
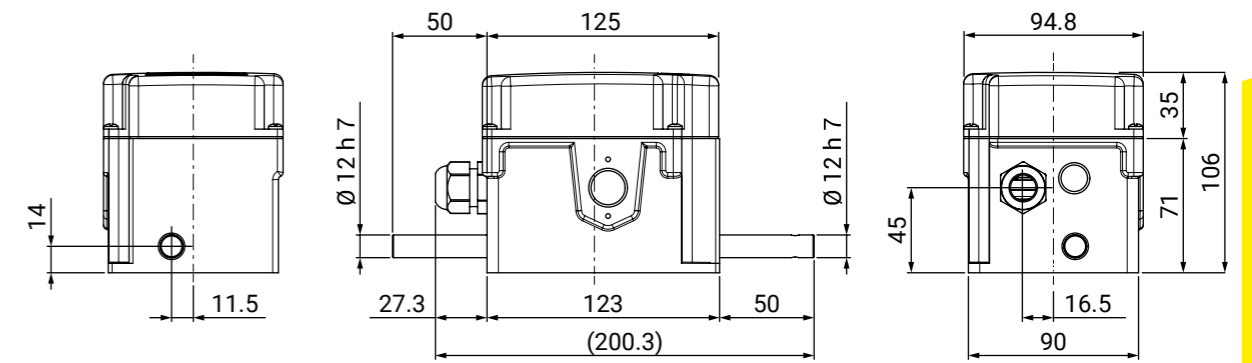
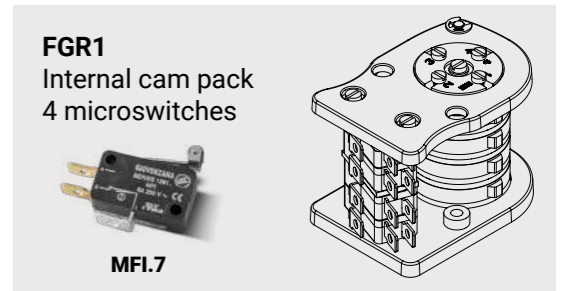

**Double overhang shaft**  
4 microswitches

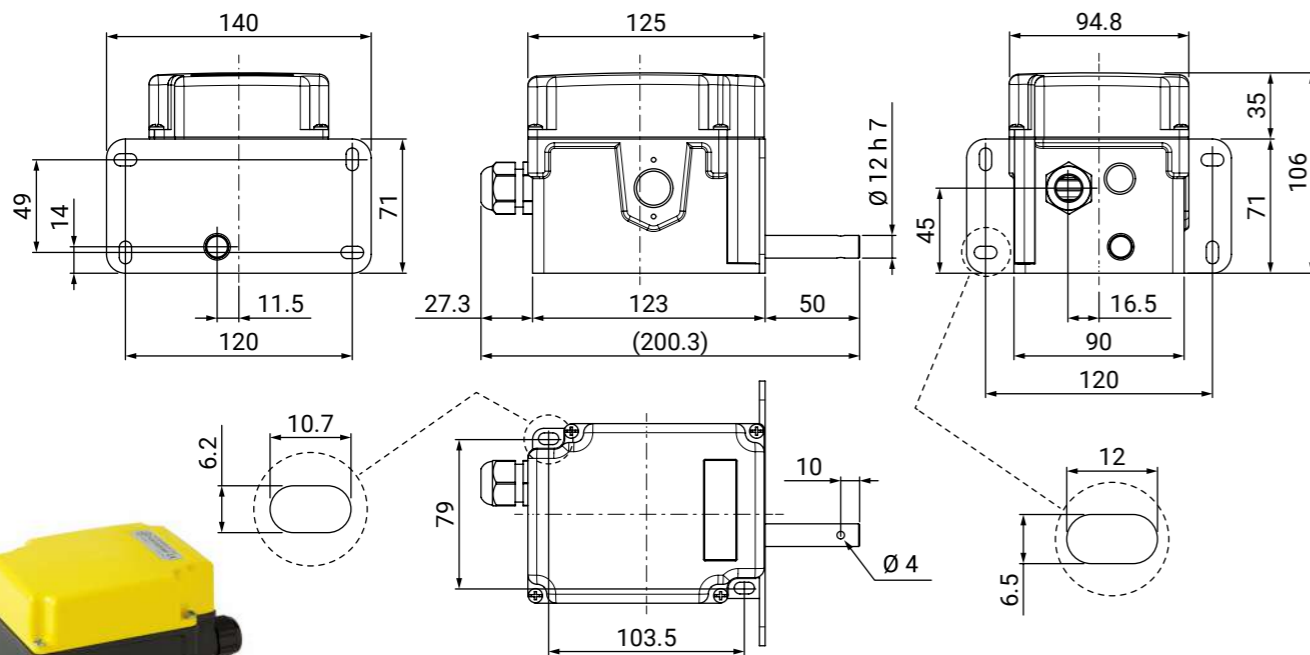

**Front fixing**  
4 microswitches

ROTARY LIMIT SWITCHES

### Coding system

The **FGR1** coding system is very clear: each block of digits identifies a specific function. The code provides all the informations that can be used to specify each customization.

FGR1	0012/0400	0-2-3-4	B	F	-	01
Series	Nr. gear ratio	Micro/cams	Shaft type	Flange	-	Options
	Between shaft and cam pack output.	0 = None 2 = Nr. 2 3 = Nr. 3 4 = Nr. 4	Blank = Single shaft B = Double overhang shaft	Blank = Without F = With flange	-	Progressive versions
<b>STANDARD ENCODING</b>						<b>OPTIONAL ENCODING</b>

### Available codes

Base fixing 4 microswitches	Front fixing 4 microswitches	Double overhang shaft 4 microswitches
FGR100124	FGR100124F	FGR100124B
FGR100334	FGR100334F	FGR100334B
FGR100504	FGR100504F	FGR100504B
FGR100754	FGR100754F	FGR100754B
FGR101004	FGR101004F	FGR101004B
FGR101504	FGR101504F	FGR101504B
FGR102004	FGR102004F	FGR102004B
FGR104004	FFGR104004F	FGR104004B

#### AVAILABLE CONTACT TYPES

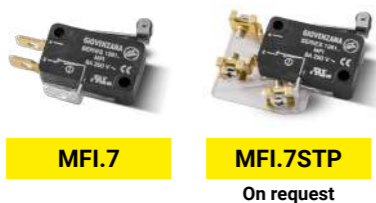

#### AVAILABLE CAM SHAPES

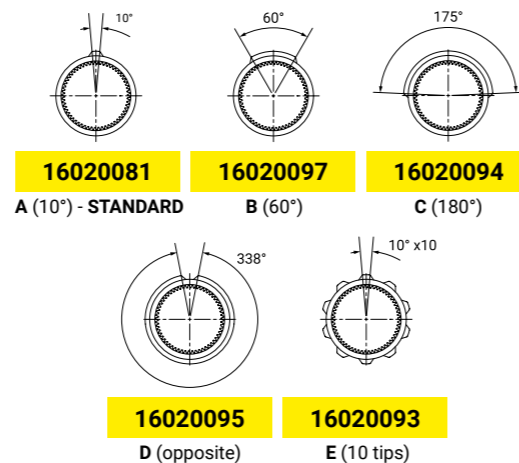

### Rotary gear limit switch

The **FGR2** is suitable for overhead crane winches, the speed control of rotating drums winding cables, machinery, etc... Equipped with adjustable micrometric screw, lives on each of the cams. The operation of the microswitches allows, by means of a screwdriver, the stroke calibration and therefore the opening or closing of the contacts according to the functional requirements.

#### General features

- Different versions available:
  - base fixing;
  - with double overhang shaft;
  - front fixing (base fixing + FLG accessory). On request.
- IP65 Protection class.
- Available in direct ratios: 1:12, 1:33, 1:50, 1:75, 1:100, 1:200 (optional on request).
- Available on request with pinions.
- Micro switches:
  - device available with 4 or 6 microswitches;
  - the working point is adjustable with a calibration screw;
  - each switch has 1NO + 1NC inside;
  - positive opening for NC contacts.

#### Compliance and certifications

- 2014/35/UE - 2014/33/UE - 2011/65/UE - 2015/863/UE
- EN 60947-1 (2007/A1 : 2011/A2 : 2014)
- EN 60947-5-1 (2004/A1 : 2009/AC : 2004/AC : 2005)
- EN 60204-1 (2006/A1 : 2009)
- EN 60529 (1991/A1 : 2000/A2 : 2013)
- EN 50581 (2012)
- IEC 63000 (2016)

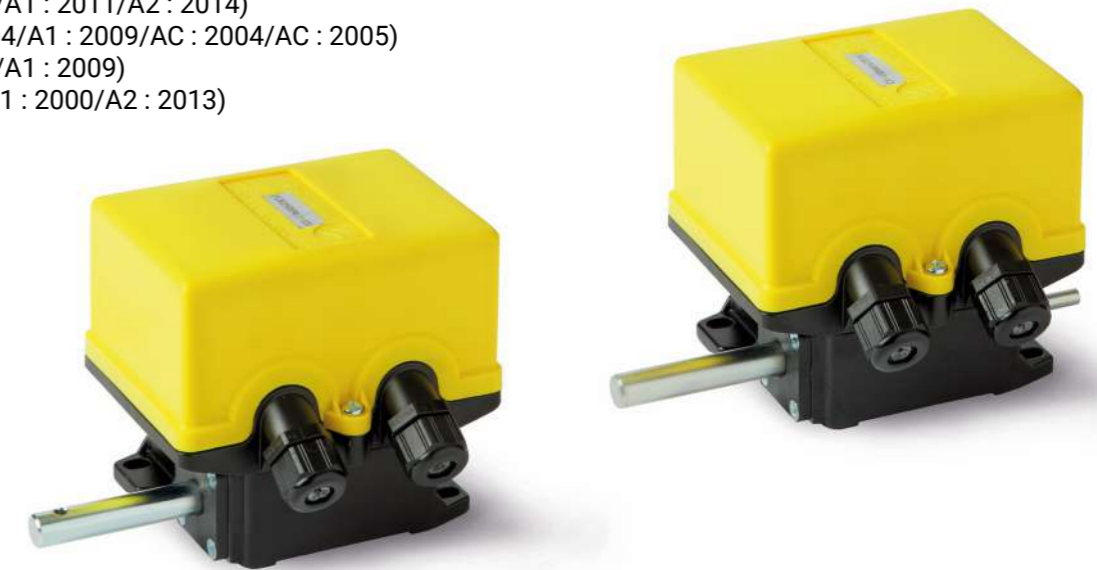

#### Base Fixing versions

X-ray views

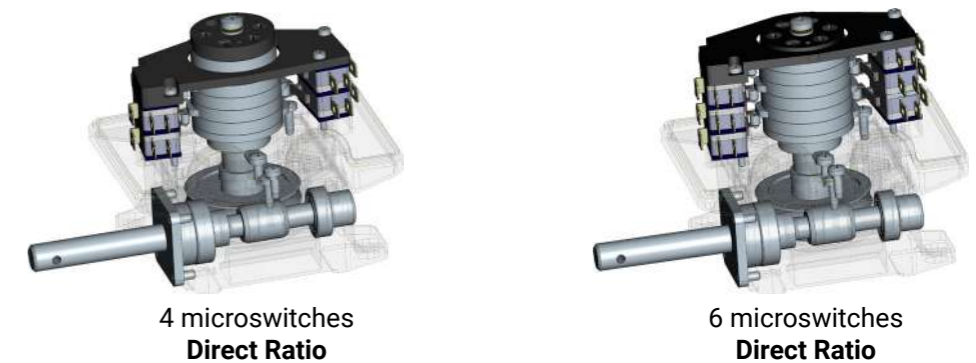



**Available codes**

**FGR2**  
Internal cam pack  
4 microswitches



**MFI.7**

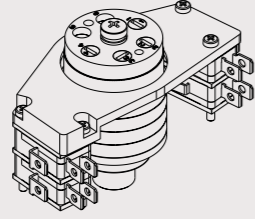

**FGR2**  
Internal cam pack  
6 microswitches



**MFI.7**

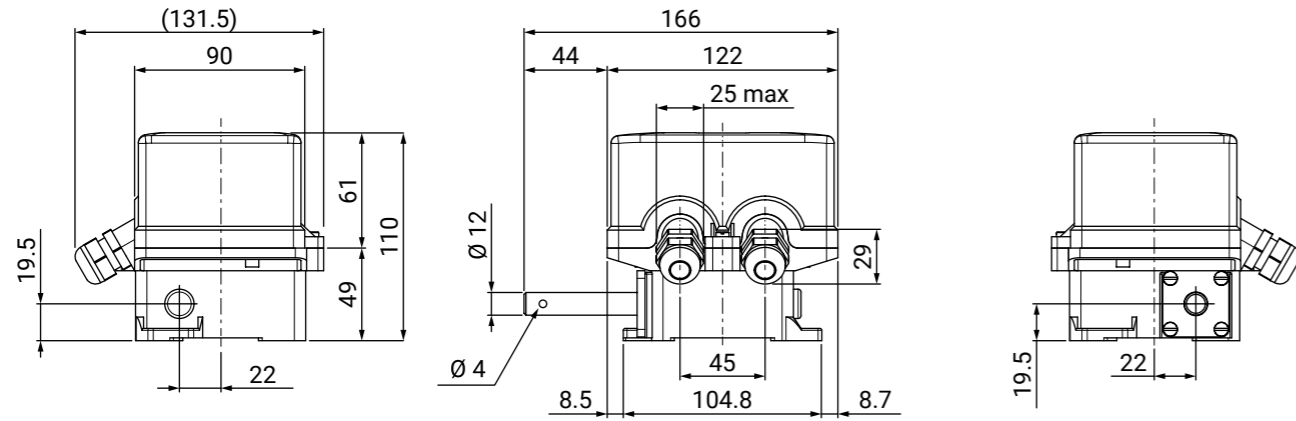
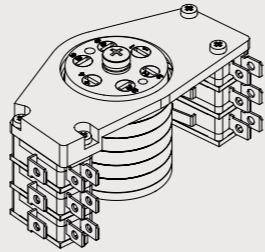

**Base fixing**  
4 or 6 microswitches

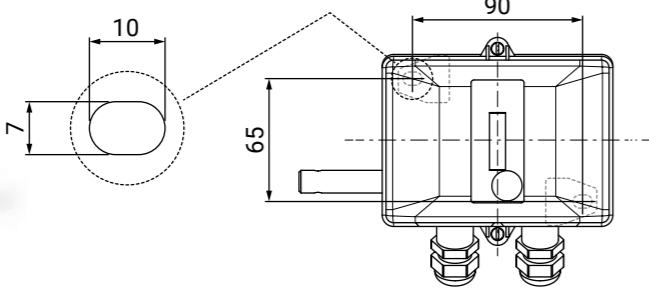

**Available codes**

**FGR2**  
Internal cam pack  
4 microswitches



**MFI.7**

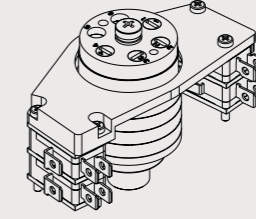

**FGR2**  
Internal cam pack  
6 microswitches



**MFI.7**

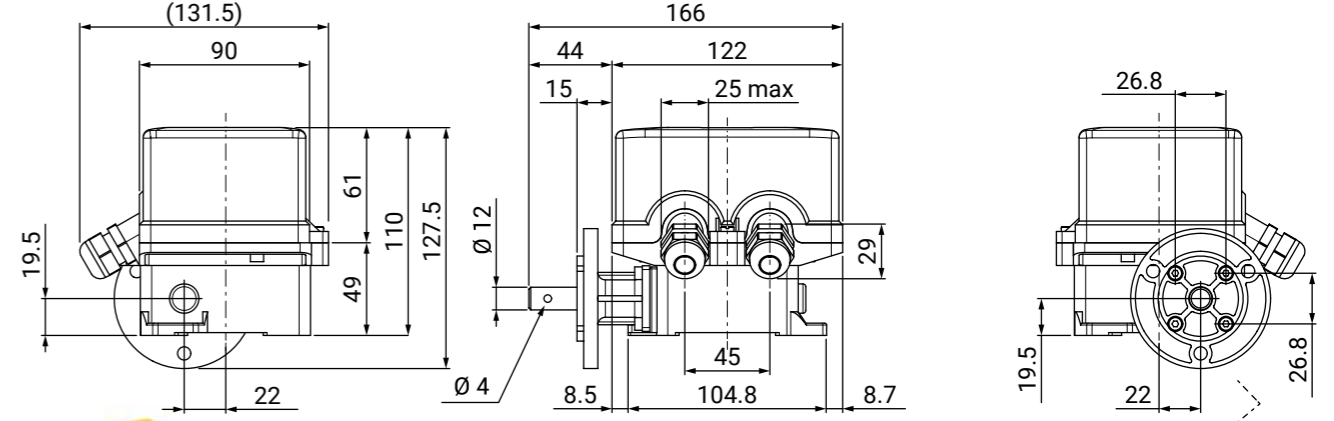
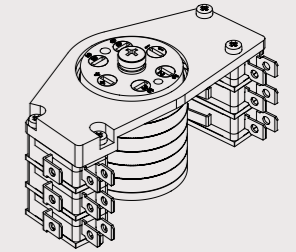

**Front fixing**  
4 or 6 microswitches

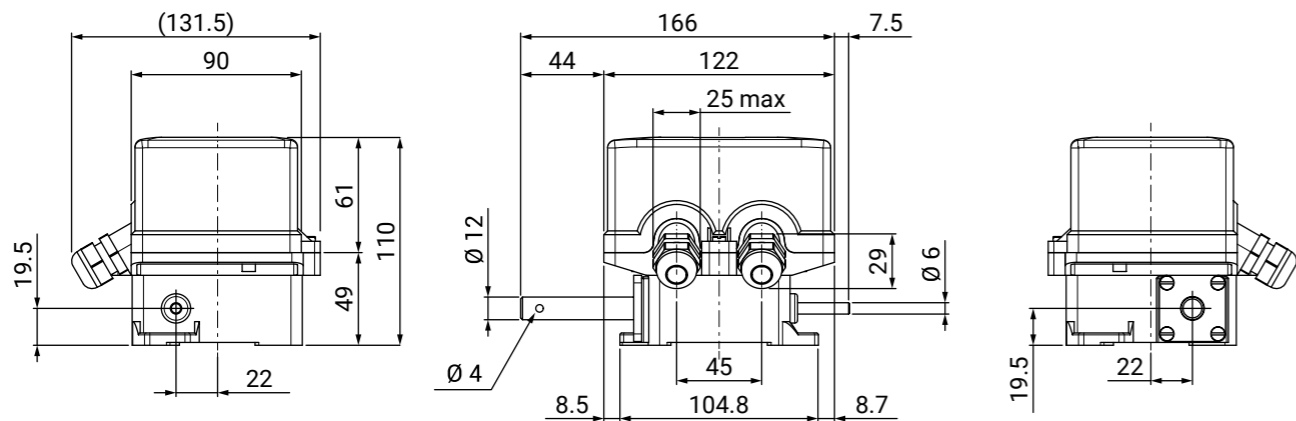
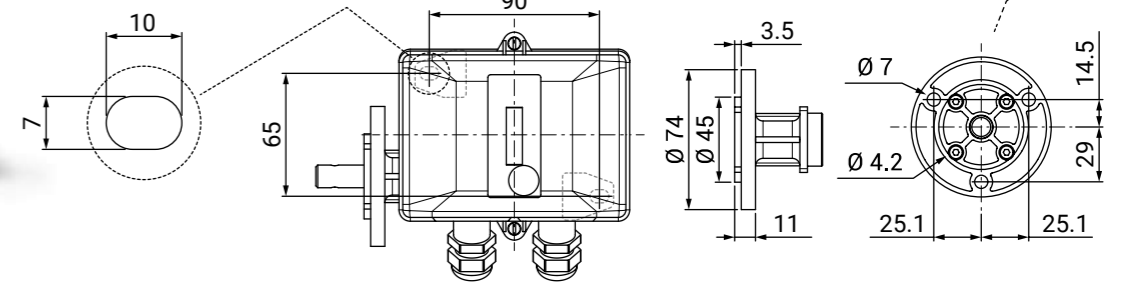

**Double overhang shaft**  
4 or 6 microswitches

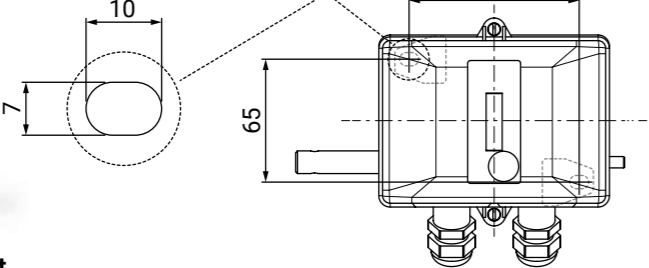

### Coding system

The **FGR2** coding system is very clear: each block of digits identifies a specific function. The code provides all the informations that can be used to specify each customization.

FGR2	F	N	006/007/008/009/010	B	6
Series	Flange	Contact type	Identity number	Shaft type	Micro/cams
	Blank = Without F = With flange	MFI.7		Blank = Single shaft B = Double overhang shaft	Blank = Nr. 4 6 = Nr. 6
STANDARD ENCODING					

### Available codes

Ratio	Base fixing 4 microswitches	Base fixing 6 microswitches	Double overhang shaft 4 microswitches	Double overhang shaft 6 microswitches
1:12	FGR2N006	FGR2N0066	FGR2N006B	FGR2N006B6
1:33	FGR2N007	FGR2N0076	FGR2N007B	FGR2N007B6
1:50	FGR2N008	FGR2N0086	FGR2N008B	FGR2N008B6
1:100	FGR2N009	FGR2N0096	FGR2N009B	FGR2N009B6
1:200	FGR2N010	FGR2N0106	FGR2N010B	FGR2N010B6

### Front fixing 4 or 6 microswitches

(A) Base fixing code plus **FLG** flange sold separately;



B) Front fixing device already assembled to be requested with code **FGRF2..**

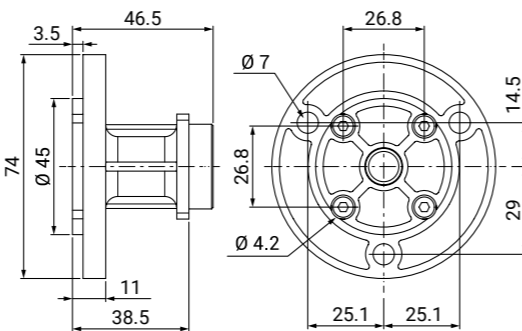

### AVAILABLE CONTACT TYPES



MFI.7

### AVAILABLE CAM SHAPES

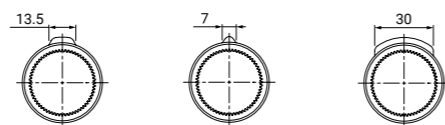

11703030  
A (30°) - STANDARD

11703031  
B (15°)

1173032  
C (90°)

### Rotary gear limit switch

The **FGR3** is a device used to control and measure the movement of industrial machines by measuring the rotation angle and/or counting the number of revolutions of a shaft. It is suitable for several applications like cranes and wind turbines.

### General features

- Different versions available:
  - base fixing;
  - with double overhang shaft;
  - front fixing (on request).
- IP66 protection class.
- Available in different ratios: from 1:8 to 1:3572 (according to the configuration).
- Available on request with pinions.
- Microswitches:
  - device available potentially until 8 microswitches;
  - the working point is adjustable with a calibration screw;
  - each switch has 1NO + 1NC inside;
  - positive opening for NC contacts.

### Compliance and certifications

- 2014/35/UE - 2014/33/UE - 2011/65/UE - 2015/863/UE
- EN 60947-1 (2007/A1 : 2011/A2 : 2014)
- EN 60947-5-1 (2004/A1 : 2009/AC : 2004/AC : 2005)
- EN 60204-1 (2006/A1 : 2009)
- EN 60529 (1991/A1 : 2000/A2 : 2013)
- EN 50581 (2012)
- IEC 63000 (2016)



### Base Fixing versions

X-ray views

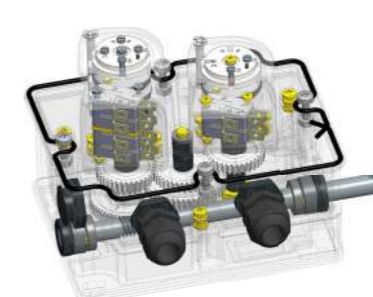

6 microswitches

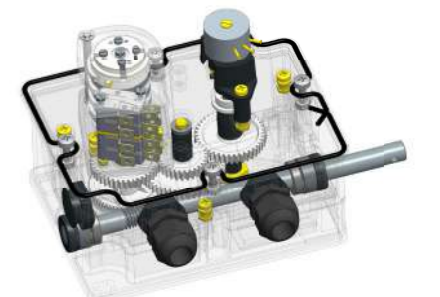

4 microswitches  
with potentiometer

### Available codes

**FGR3**  
Internal cam pack  
4 microswitches



MFI.7

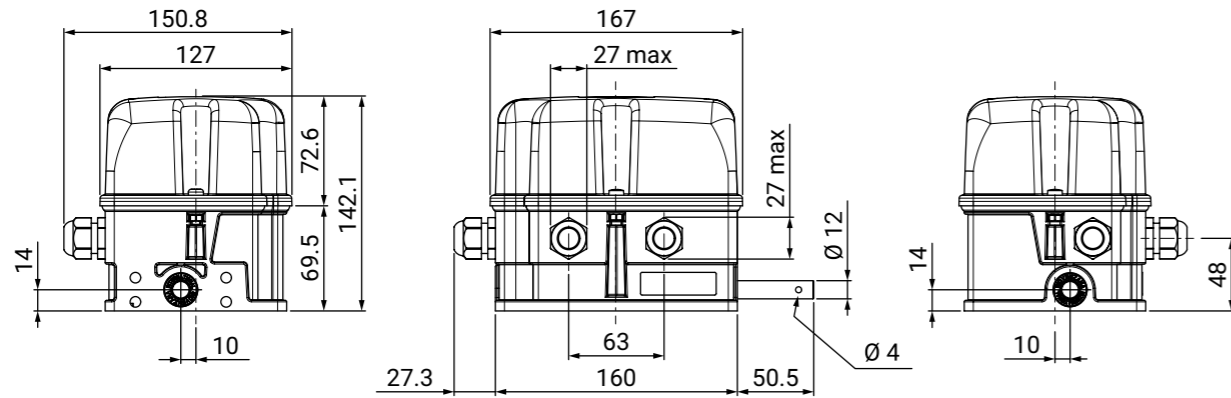
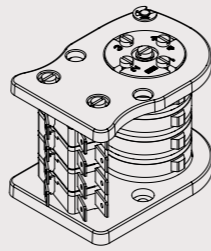

Base fixing

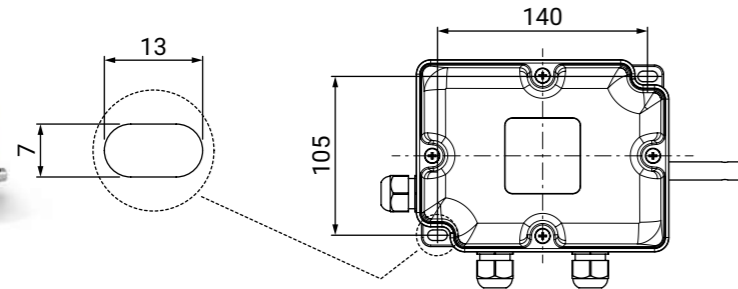

### Coding system

The **FGR3** coding system is very clear: each block of digits identifies a specific function. The code provides all the informations that can be used to specify each customization.

FGR3	0-8	001-999	0-2-3-4	1-2-3-4	-	00-99
Series	Encoder / Potentiometer	Nr. gear ratio	Micro/cams	Shaft type	-	Options
	0 = No sensors 1 = Incremental Encoder D22 2 = Potentiometer 2.5 K $\Omega$ 3 = Potentiometer 5 K $\Omega$ 4 = Potentiometer 10 K $\Omega$ 5 = Absolut Encoder D36 6 = Incremental Encoder P/P 5000 imp. 7 = Absolut/Incremental Encoder D36 8 = Absolut Encoder D58 A ... Z = Custom on request	Between: - shaft and cam pack output; - shaft and sensor output; - both.	0 = None 2 = Nr. 2 3 = Nr. 3 4 = Nr. 4 5 = Nr. 5	1 = Single shaft and reduction in cam output. 2 = Double overhang shaft and reduction in cam output. 3 = Single shaft and reduction in both cam and sensor output. 4 = Double overhang shaft and reduction both in cam output and in sensor output.	-	Progressive versions

### Available codes



### Available options

- Can be supplied with front fixing. Available different typologies of flanged accessories, on request.
- Can be equipped with MFI.7 microswitches (standard version) or with MFI.7D micro switches (gold contact blocks - offshore use).
- Can be equipped with incremental or absolut encoder, available also with external encoder mounted.

The **FGR3 series is a totally customizable products.**  
Create your own devices using the FGR3 coding system!

#### AVAILABLE CONTACT TYPES



MFI.7

MFI.7D

On request  
Offshore use

#### AVAILABLE CAM SHAPES

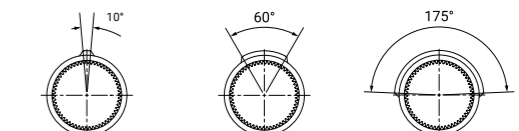

16020081  
A (10°) - STANDARD

16020097  
B (60°)

16020094  
C (180°)

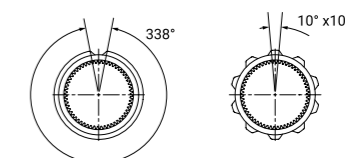

16020095  
D (opposite)

16020093  
E (10° x10)

### Water jet cut pinions

Our measuring pinions are specially manufactured for use with encoders and geared limit switches.  
Pinions thickness = 10 mm.

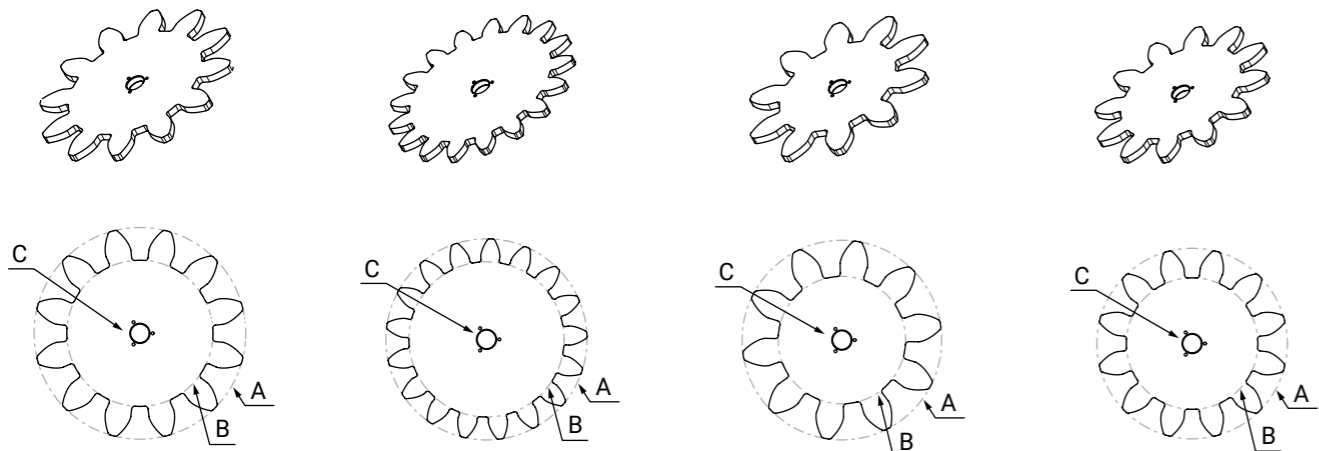

<b>16020051</b> M20 - Z12 A = Ø 280 / B = Ø 193.2	<b>16020052</b> M14 - Z17 A = Ø 266 / B = Ø 205.24	<b>16020053</b> M22 - Z10 A = Ø 264 / B = Ø 168.52	<b>16020054</b> M18 - Z12 A = Ø 252 / B = Ø 173.88
---------------------------------------------------------	----------------------------------------------------------	----------------------------------------------------------	----------------------------------------------------------

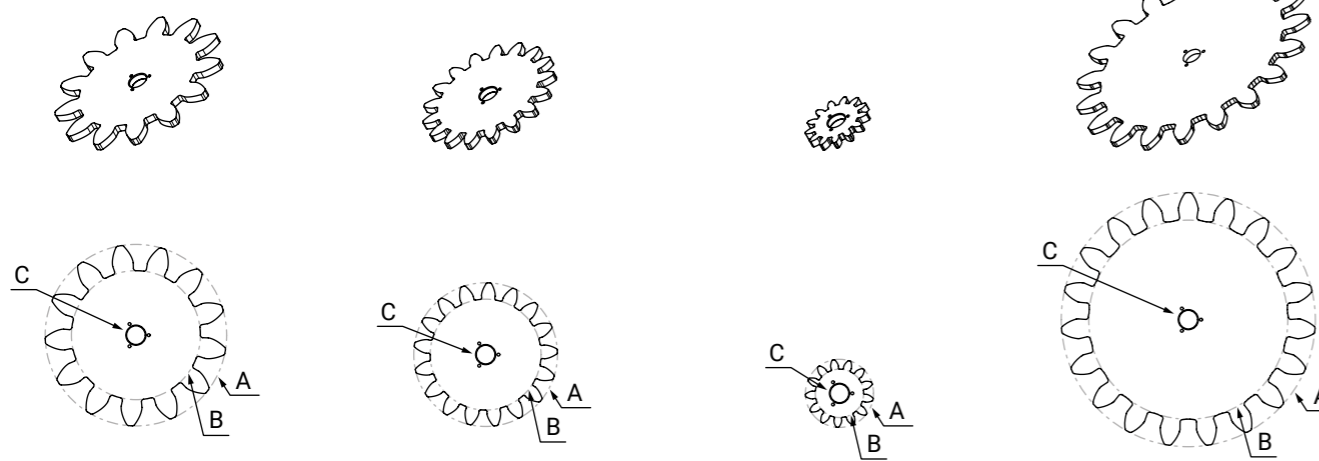

<b>16020055</b> M16 - Z13 A = Ø 240 / B = Ø 170.56	<b>16020056</b> M10 - Z17 A = Ø 190 / B = Ø 146.6	<b>16020057</b> M6 - Z13 A = Ø 90 / B = Ø 63.96	<b>16020070</b> M16 - Z19 A = Ø 336 / B = Ø 263,2
----------------------------------------------------------	---------------------------------------------------------	-------------------------------------------------------	---------------------------------------------------------

**Detail C**  
For all previous pinions.  
Finished product measurements.

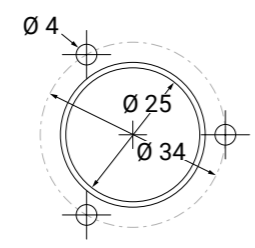

### Injection moulded pinions

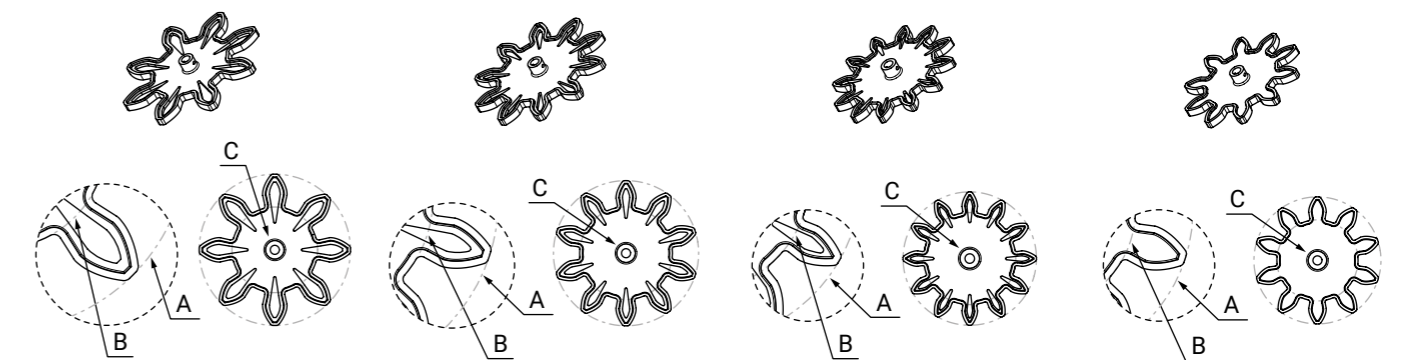

<b>16020058</b> M20 - Z8 A = Ø 200 / B = Ø 113.2	<b>16020059</b> M13 - Z10 A = Ø 192 / B = Ø 122.56	<b>16020060</b> M12 - Z12 A = Ø 176.4 / B = Ø 121.716	<b>16020061</b> M14 - Z10 A = Ø 168 / B = Ø 107.24
--------------------------------------------------------	----------------------------------------------------------	-------------------------------------------------------------	----------------------------------------------------------

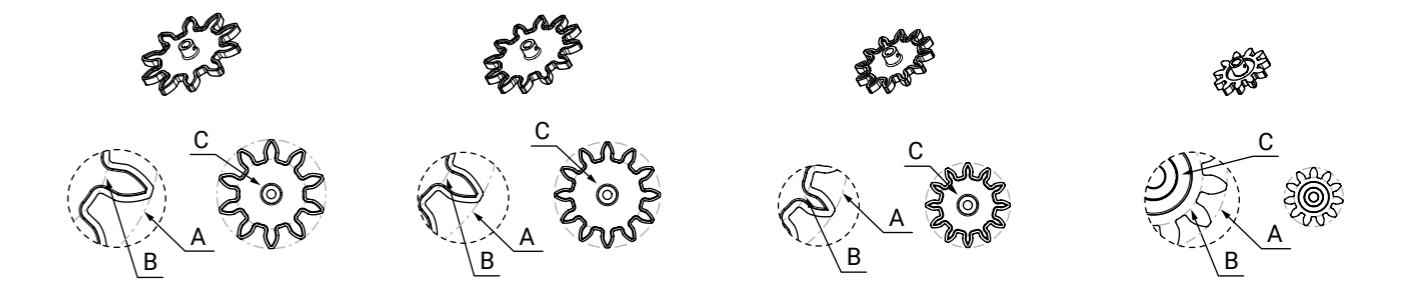

<b>16020062</b> M12 - Z10 A = Ø 144 / B = Ø 91.92	<b>16020063</b> M10 - Z12 A = Ø 140 / B = Ø 96.6	<b>16020064</b> M8 - Z12 A = Ø 112 / B = Ø 77.28	<b>16020065</b> M6 - Z11 A = Ø 78 / B = Ø 51.96
---------------------------------------------------------	--------------------------------------------------------	--------------------------------------------------------	-------------------------------------------------------

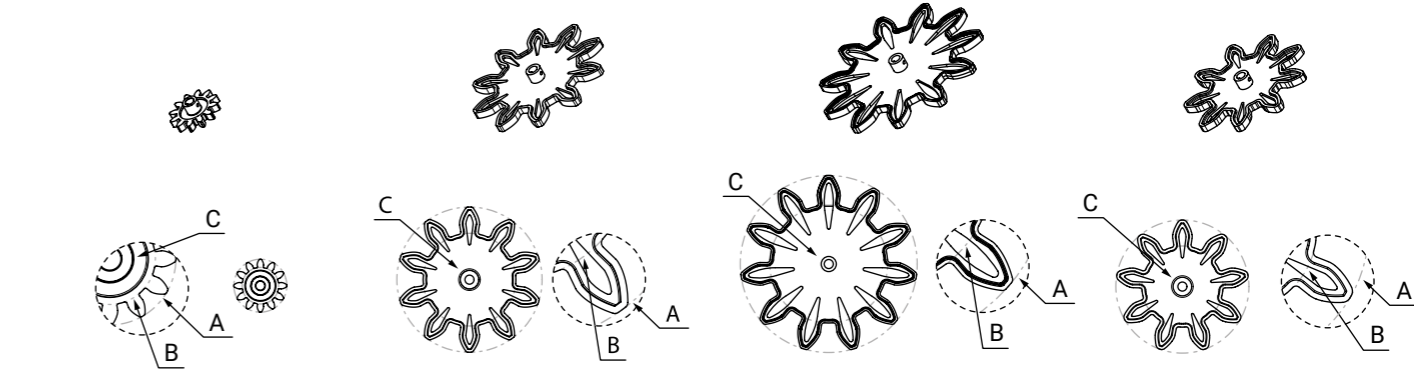

<b>16020066</b> M5 - Z12 A = Ø 70 / B = Ø 48.3	<b>16020068</b> M16 - Z20 A = Ø 192 / B = Ø 122.56	<b>16020069</b> M18 - Z11 A = Ø 234 / B = Ø 155.81	<b>16020071</b> M16 - Z19 A = Ø 176 / B = Ø 107.285
------------------------------------------------------	----------------------------------------------------------	----------------------------------------------------------	-----------------------------------------------------------

**Detail C**  
For all previous pinions.

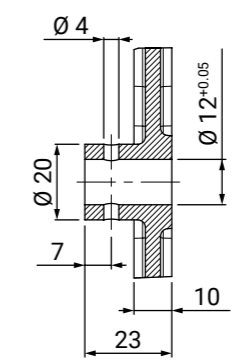

### Wheel coupling sleeve for water jet cut pinions

For the installation of the water jet cut pinions, the wheel coupling sleeve (code: 16020050) is required.

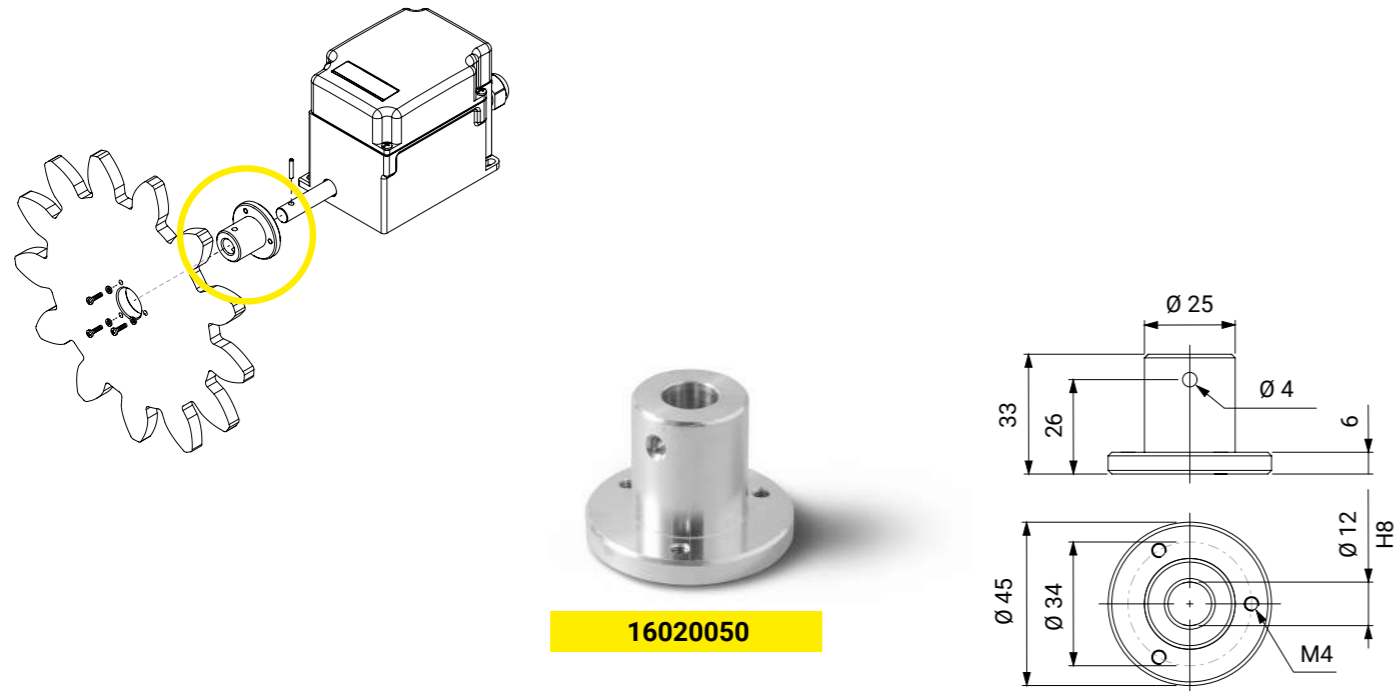

### Oldham coupling for FGR1, FGR2, FGR3



**FGH**

- Oldham coupling
- Locking screw 4 x 40
- Spheres Ø 3 mm

The hole on the coupling may not be present

Maximum axial disalignment obtained without locking screw

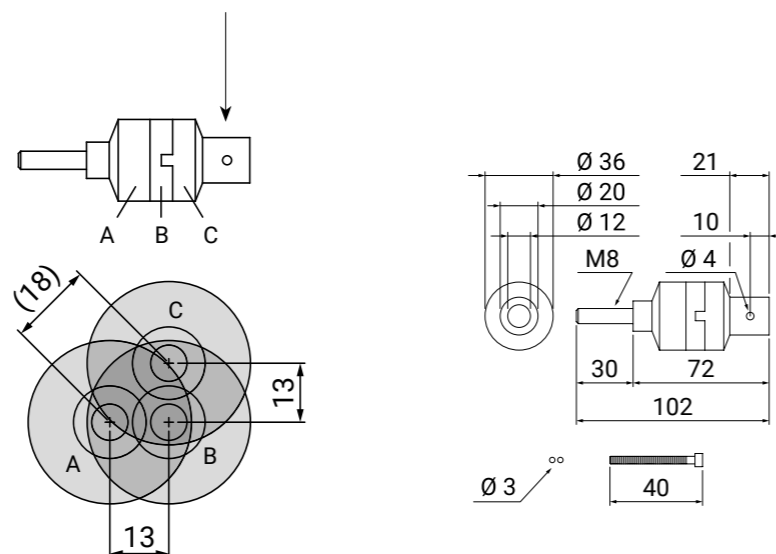

### Cam shapes for FGR0, FGR1, FGR3

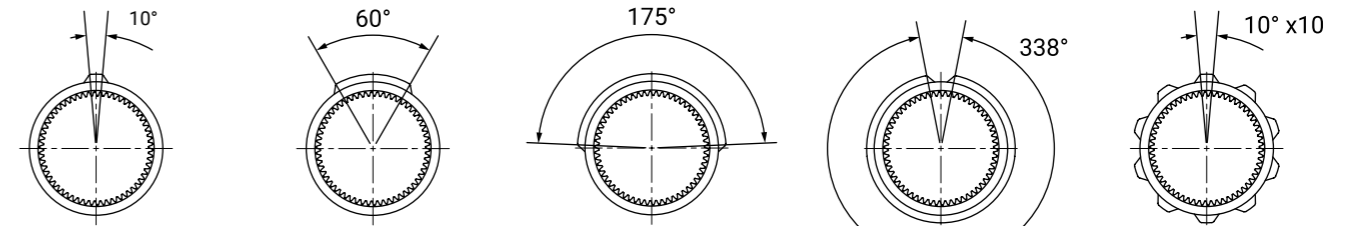

<b>16020081</b>	<b>16020097</b>	<b>16020094</b>	<b>16020095</b>	<b>16020093</b>
A (10°) - STANDARD	B (60°)	C (180°)	D (opposite)	E (10 tips)

### Cam shapes for FGR2

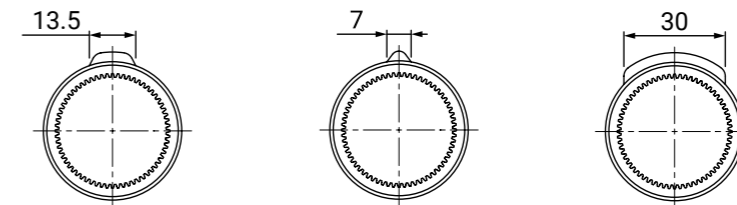

<b>11703030</b>	<b>11703031</b>	<b>11703032</b>
A (30°) - STANDARD	B (15°)	C (90°)

Available customised versions on request.

# POSITION LIMIT SWITCHES

Giovenzana offers four different typologies of **position limit switches**, used in particular in industrial and construction lifting plants, in the automation industry, in stage technology, in particular to control hoists, winches and machine tools.

The range of position limit switches includes thermoplastic material limit switches allowing for diversified switch activation types:

- with cross rods;
- with single rod with roller;
- with lever.

Each position limit switches has specific features allowing to choose the limit switch that best suit the specific customers' needs.

All position limit switches are CE marked and they are manufactured in compliance with the directives and standards actually in force.

Furthermore, position limit switches are also EAC and CCC certified, for the Eurasian and Chinese markets, as proof of the importance given to the quality levels required in different countries.

## APPLICATIONS

Our **position limit** switches are used to control several handling system:

### SOPHISTICATED CRANE SYSTEM

The unit controls power operating system (ex. PLC) and allows the crane to slow-down and/or to stop running.

### HOIST

The unit is used to stop the hoist running whenever it reaches a "limit" position.

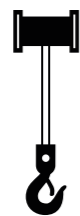

HOIST

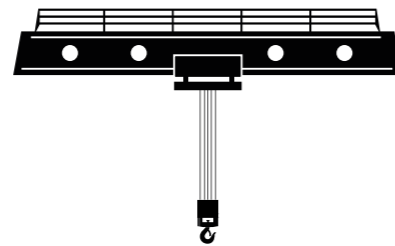

CRANE

## FEATURES

- Different versions are available for all standard system.
- Every customization is available upon request.

## SERIES



FFH



FFH2C-1



FCR



FCP245

## BENEFITS

- › Precise, reliable and safe devices
- › Good handling control ensured
- › Guaranteed maximum operating safety
- › Prevention of personal injury and damage to objects

**FFH**
**FCR**
**FFH2C-1**
**FCP245**
**GENERAL CHARACTERISTICS**

<b>STANDARDS</b>	IEC /EN 60497/3	IEC /EN 60497/3
<b>CASE</b>	Self extinguishing housing V0 UL94	Self extinguishing housing V0 UL94
<b>PROTECTION CLASS</b>	IP67 - Double insulation	IP65 - Double insulation (IEC / EN 60529)
<b>CABLE ENTRY</b>	M16 / M20	Nr 1 Ø 22.5 mm
<b>VERSIONS</b>	Single or double speed motor configuration. 3, 4 or 4 with mechanical stop positions.	Single or double speed motor configuration. 3, 4 or 4 with mechanical stop positions.
<b>NOTES</b>	Fully adjustable aluminium rods □ 2x200 mm with "0" indicator. Reinforced mechanical stop.	Fully adjustable aluminium rods □ 6x300 mm with "0" indicator. Reinforced mechanical stop.
<b>AMBIENTAL TEMPERATURE</b>	Operating: -25°C ... +55°C Storage: -30°C ... +70°C	Operating: -25°C ... +55°C Storage: -30°C ... +70°C

**GENERAL CHARACTERISTICS**

<b>STANDARDS</b>	IEC /EN 60497/3	IEC /EN 60497/3, EN 81-1
<b>CASE</b>	Self extinguishing housing V0 UL94	Self extinguishing housing V0 UL94
<b>PROTECTION CLASS</b>	IP65 - Double insulation (IEC / EN 60529)	IP65 - Double insulation (IEC / EN 60529)
<b>CABLE ENTRY</b>	1 x M16 + 1 x M20	M20 (max 8)
<b>VERSIONS</b>	Single speed motor configuration. Other configurations on request.	Two pole on-off switch. Other configurations on request.
<b>NOTES</b>	Fully adjustable aluminium rod □ 6x120 mm with "0" indicator. Reinforced mechanical stop. Rubber covering wheel.	Reinforced mechanical stop.
<b>AMBIENTAL TEMPERATURE</b>	Operating: -25°C ... +55°C Storage: -30°C ... +70°C	Operating: -25°C ... +55°C Storage: -30°C ... +70°C

**ELECTRICAL CHARACTERISTICS**

<b>PRODUCT ID</b>	P016 Giovenzana Cam switch line	P016 Giovenzana Cam switch line
<b>STANDARDS</b>	IEC/EN 60947/3 – UL508	IEC/EN 60947/3 – UL508
<b>MARKING</b>	CE, IMQ, RINA, EAC, CCC, cULus, cCSAus	CE, IMQ, RINA, EAC, CCC, cULus, cCSAus
<b>RATED OPERATING VOLTAGE - U<sub>e</sub></b>	690V	690V
<b>RATED INSULATION VOLTAGE - U<sub>i</sub></b>	690V	690V
<b>RATED IMPULSE WITHSTAND VOLTAGE - U<sub>imp</sub></b>	4kV	4kV
<b>RATED THERMAL CURRENT - I<sub>th</sub></b>	16A	16A
<b>ENCLOSED THERMAL CURRENT - I<sub>the</sub></b>	16A	16A
<b>RATED OPERATING CURRENT</b>	AC21A AC22A	16A - 690 V AC
	AC23A 3ph 230V	13A - 4 kW
	AC23A 3ph 400V	13A - 7.5 kW
<b>FREQUENCY</b>	50 / 60 Hz	50 / 60 Hz
<b>CONTACTS</b>	Double gap positive opening (→)	Double gap positive opening (→)
<b>BLOCK CALIBER</b>	A3 (EN 60947-1)	A3 (EN 60947-1)
<b>TERMINAL SCREW</b>	M3.5	M3.5
<b>TIGHTENING TORQUE</b>	0.8 Nm / 7.2 lbin (EN60947-1) 7.5 lbin / 0.85 Nm (UL508)	0.8 Nm / 7.2 lbin (EN60947-1) 7.5 lbin / 0.85 Nm (UL508)
<b>CONNECTABLE SECTION</b>	Flexible conductors	1 x 0.75 / 4 ... 2 x 0.75 / 2.5 mm <sup>2</sup> 10 ... 18 AWG
	Solid conductors	1 x 0.75 / 4 ... 2 x 0.75 / 2.5 mm <sup>2</sup> 10 ... 18 AWG

**ELECTRICAL CHARACTERISTICS**

<b>PRODUCT ID</b>	PX20 Giovenzana Cam switch line	CX40 Giovenzana Cam switch line
<b>STANDARDS</b>	IEC/EN 60947/3 – UL508	IEC/EN 60947/3 – UL508
<b>MARKING</b>	CE, IMQ, RINA, EAC, CCC, cULus, cCSAus	CE, IMQ, RINA, EAC, CCC, cULus, cCSAus
<b>RATED INSULATION VOLTAGE - U<sub>i</sub></b>	690V	690V
<b>RATED INSULATION VOLTAGE - U<sub>i</sub></b>	690V	690V
<b>RATED IMPULSE WITHSTAND VOLTAGE - U<sub>imp</sub></b>	5kV	10kV
<b>RATED THERMAL CURRENT - I<sub>th</sub></b>	20A	40A
<b>ENCLOSED THERMAL CURRENT - I<sub>th</sub></b>	20A	40A
<b>RATED OPERATING CURRENT</b>	AC21A AC22A	20A - 690 V AC
	AC23A 3ph 230V	16A - 5 kW
	AC23A 3ph 400V	16A - 9 kW
<b>FREQUENCY</b>	50 / 60 Hz	50 / 60 Hz
<b>CONTACTS</b>	Double gap positive opening (→)	Double gap positive opening (→)
<b>BLOCK CALIBER</b>	A3 (EN 60947-1)	A5 (EN 60947-1)
<b>TERMINAL SCREW</b>	M3.5	M4
<b>TIGHTENING TORQUE</b>	0.8 Nm / 7.2 lbin (EN60947-1) 7.5 lbin / 0.85 Nm (UL508)	1.2 Nm (EN60947-1) 10.6 lbin (UL508)
<b>CONNECTABLE SECTION</b>	Flexible conductors	1 x 0.75 / 4 ... 2 x 0.75 / 2.5 mm <sup>2</sup> 10 ... 18 AWG
	Solid conductors	1 x 0.75 / 4 ... 2 x 0.75 / 2.5 mm <sup>2</sup> 10 ... 18 AWG

**POSITION LIMIT SWITCHES**

# FFH

## Position limit switch



### Position limit switch with reduced overall dimensions

The **FFH position limit switch** is used to control several handling systems:

- **Bridge cranes:** the limit switch controls the operating system, for example a PLC, and allows the bridge crane to slow down or stop.
- **Hoists:** the limit switch is used to stop the hoist whenever it reaches a limit position.

### Features

- Designed to ensure excellent performances in the most challenging operating conditions.
- Compact design to be adapted in any application need.
- Reduced overall dimensions compared to the historical FCR series.
- Arranged with 4 fixing holes.
- Positive opening NC contacts for safety functions.
- IP67 Protection degree.
- Aluminium rods with 6x6 mm section and enclosure in thermoplastic material.
- Cross rods with 4 maintained positions every 90°.
- Arranged with 2 outputs for cable clamps to reduce installation time and make wiring easier.
- Available different versions, also customizable on request.

### Compliance and certifications

- 2014/35/UE - 2011/65/UE - 2015/863/UE
- EN 60947-1 (2007/A1 : 2011/A2 : 2014)
- EN 60947-3 (2009/A1 : 2012/A2 : 2015)
- EN 60204-1 (2006/A1 : 2009)
- EN 60529 (1991/A1 : 2000/A2 : 2013)
- EN 50581 (2012)
- IEC 63000 (2016)

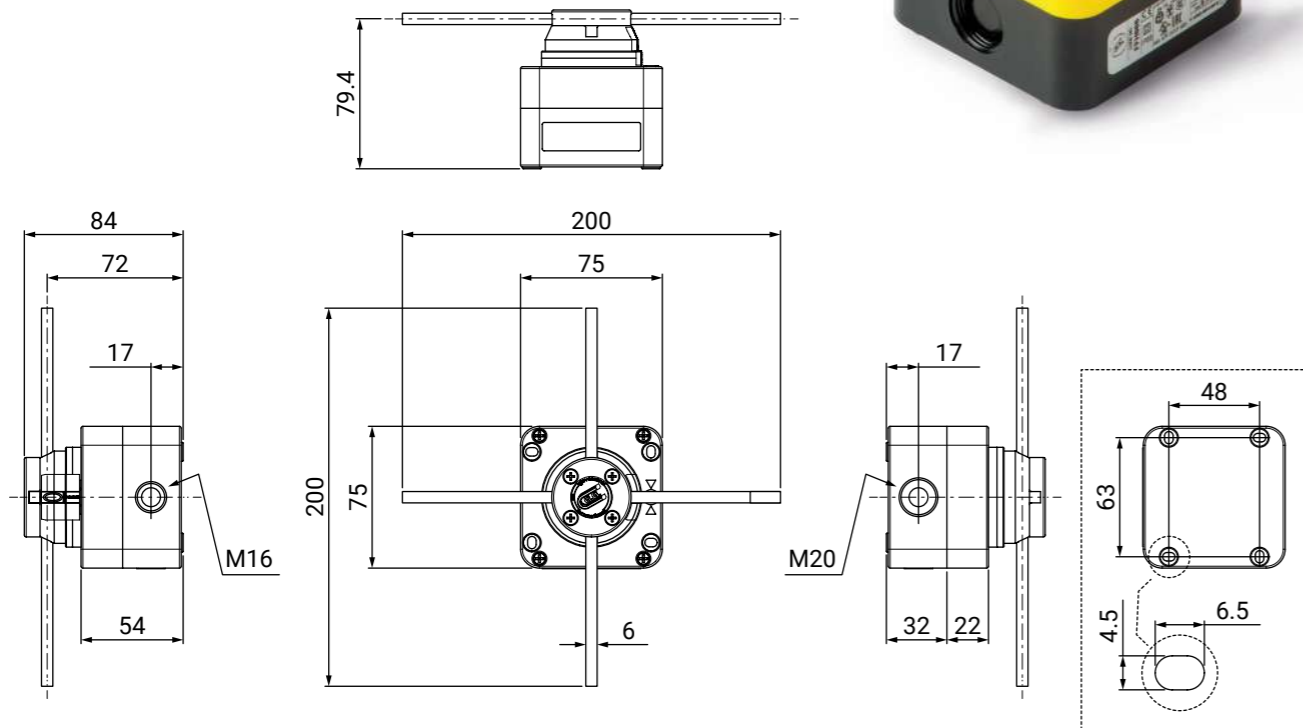

**FFH**  
Internal  
cam switch  
**P016 line**



 contact open  contact close

### Available codes

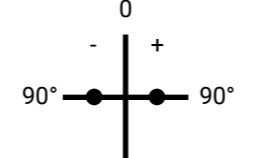
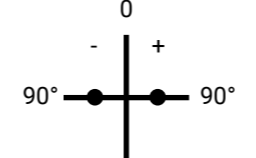
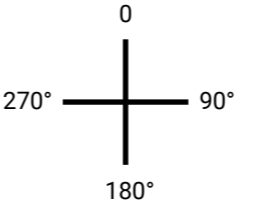
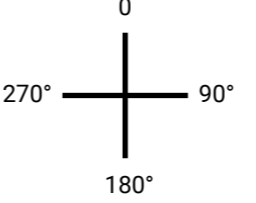
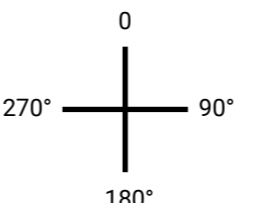
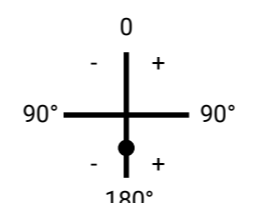
	<p><b>FFH001</b></p> <ul style="list-style-type: none"> <li>Single speed</li> <li>3 positions</li> <li>With mechanical interlock ●</li> </ul>	<p>contacts</p> <table border="1"> <tr> <td>3-4</td> <td></td> <td></td> <td></td> </tr> <tr> <td>1-2</td> <td></td> <td></td> <td></td> </tr> <tr> <td></td> <td>- 90°</td> <td>0</td> <td>+ 90°</td> </tr> </table> <p>positions</p>	3-4				1-2					- 90°	0	+ 90°																		
3-4																																
1-2																																
	- 90°	0	+ 90°																													
	<p><b>FFH002</b></p> <ul style="list-style-type: none"> <li>Single speed</li> <li>3 positions</li> <li>With mechanical interlock</li> </ul>	<p>contacts</p> <table border="1"> <tr> <td>7-8</td> <td></td> <td></td> <td></td> </tr> <tr> <td>5-6</td> <td></td> <td></td> <td></td> </tr> <tr> <td>3-4</td> <td></td> <td></td> <td></td> </tr> <tr> <td>1-2</td> <td></td> <td></td> <td></td> </tr> <tr> <td></td> <td>- 90°</td> <td>0</td> <td>+ 90°</td> </tr> </table> <p>positions</p>	7-8				5-6				3-4				1-2					- 90°	0	+ 90°										
7-8																																
5-6																																
3-4																																
1-2																																
	- 90°	0	+ 90°																													
	<p><b>FFH003</b></p> <ul style="list-style-type: none"> <li>Single speed</li> <li>4 positions</li> <li>Without mechanical interlock</li> </ul>	<p>contacts</p> <table border="1"> <tr> <td>3-4</td> <td></td> <td></td> <td></td> <td></td> </tr> <tr> <td>1-2</td> <td></td> <td></td> <td></td> <td></td> </tr> <tr> <td></td> <td>0</td> <td>90°</td> <td>180°</td> <td>270°</td> </tr> </table> <p>positions</p>	3-4					1-2						0	90°	180°	270°															
3-4																																
1-2																																
	0	90°	180°	270°																												
	<p><b>FFH004</b></p> <ul style="list-style-type: none"> <li>Single speed</li> <li>4 positions</li> <li>Without mechanical interlock</li> </ul>	<p>contacts</p> <table border="1"> <tr> <td>5-6</td> <td></td> <td></td> <td></td> <td></td> </tr> <tr> <td>1-2</td> <td></td> <td></td> <td></td> <td></td> </tr> <tr> <td></td> <td>0</td> <td>90°</td> <td>180°</td> <td>270°</td> </tr> </table> <p>positions</p>	5-6					1-2						0	90°	180°	270°															
5-6																																
1-2																																
	0	90°	180°	270°																												
	<p><b>FFH005</b></p> <ul style="list-style-type: none"> <li>Single speed</li> <li>4 positions</li> <li>Without mechanical interlock</li> </ul>	<p>contacts</p> <table border="1"> <tr> <td>5-6</td> <td></td> <td></td> <td></td> <td></td> </tr> <tr> <td>1-2</td> <td></td> <td></td> <td></td> <td></td> </tr> <tr> <td></td> <td>0</td> <td>90°</td> <td>180°</td> <td>270°</td> </tr> </table> <p>positions</p>	5-6					1-2						0	90°	180°	270°															
5-6																																
1-2																																
	0	90°	180°	270°																												
	<p><b>FFH006</b></p> <ul style="list-style-type: none"> <li>Double speed</li> <li>4 positions</li> <li>With mechanical interlock ●</li> </ul>	<p>contacts</p> <table border="1"> <tr> <td>7-8</td> <td></td> <td></td> <td></td> <td></td> <td></td> </tr> <tr> <td>5-6</td> <td></td> <td></td> <td></td> <td></td> <td></td> </tr> <tr> <td>3-4</td> <td></td> <td></td> <td></td> <td></td> <td></td> </tr> <tr> <td>1-2</td> <td></td> <td></td> <td></td> <td></td> <td></td> </tr> <tr> <td></td> <td>- 180°</td> <td>- 90°</td> <td>0</td> <td>+ 90°</td> <td>+ 180°</td> </tr> </table> <p>positions</p>	7-8						5-6						3-4						1-2							- 180°	- 90°	0	+ 90°	+ 180°
7-8																																
5-6																																
3-4																																
1-2																																
	- 180°	- 90°	0	+ 90°	+ 180°																											

POSITION LIMIT SWITCHES



# FCR

## Position limit switch

### Position limit switch

The **FCR position limit switch** is used to control several handling systems:

- **Bridge cranes:** the limit switch controls the operating system, for example a PLC, and allows the bridge crane to slow down or stop.
- **Hoists:** the limit switch is used to stop the hoist whenever it reaches a limit position.

### Features

- Designed to guarantee excellent performance in the most challenging operating conditions.
- Arranged with 4 fixing holes.
- Positive opening NC contacts for safety functions.
- IP65 protection degree.
- Aluminium rods with 6x6 mm section and enclosure in thermoplastic material.
- Cross rods with 4 maintained positions every 90°.
- Arranged with 1 output for cable clamps to reduce installation time and make wiring easier.
- Available different versions, also customizable on request.

### Compliance and certifications

- 2014/35/UE - 2011/65/UE - 2015/863/UE
- EN 60947-1 (2007/A1 : 2011/A2 : 2014)
- EN 60947-3 (2009/A1 : 2012/A2 : 2015)
- EN 60204-1 (2006/A1 : 2009)
- EN 60529 (1991/A1 : 2000/A2 : 2013)
- EN 50581 (2012)
- IEC 63000 (2016)

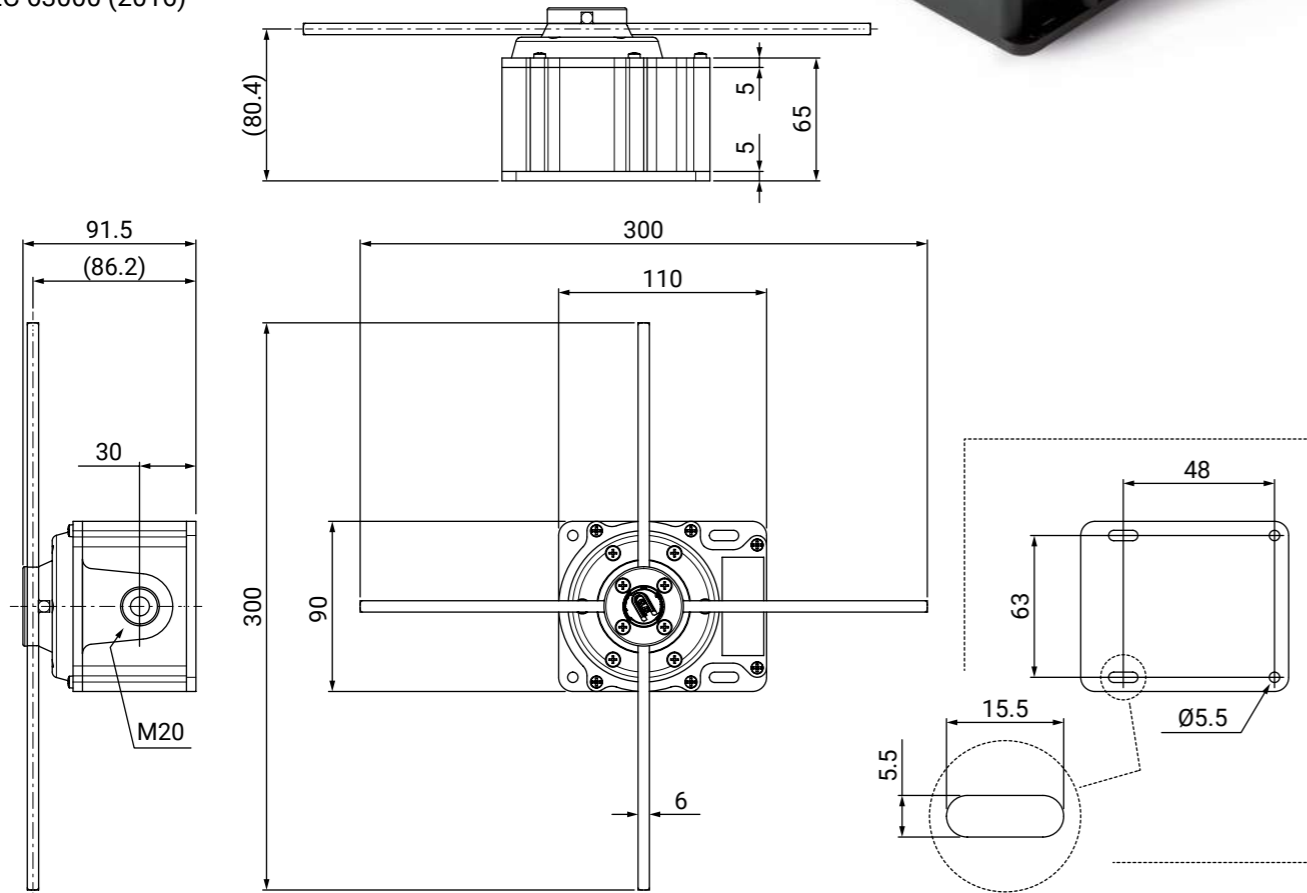

**FCR**  
Internal  
cam switch  
**P016 line**



 contact open  contact close

### Available codes

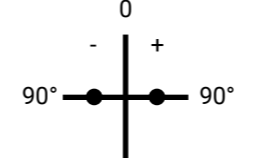
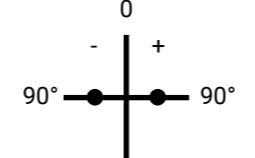
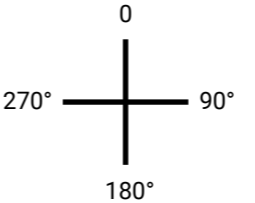
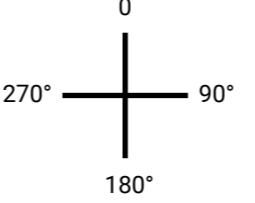
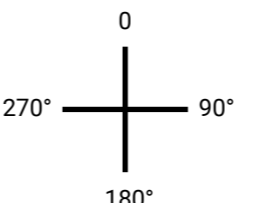
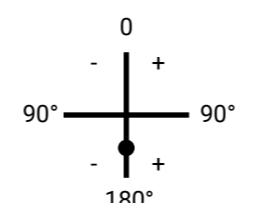
	<p><b>FCR001</b></p> <p>Single speed 3 positions With mechanical interlock ●</p>	<p>contacts</p> <table border="1"> <tr> <td>3-4</td> <td></td> <td></td> <td></td> </tr> <tr> <td>1-2</td> <td></td> <td></td> <td></td> </tr> </table> <p>- 90° 0 + 90° positions</p>	3-4				1-2																			
3-4																										
1-2																										
	<p><b>FCR002</b></p> <p>Single speed 3 positions With mechanical interlock ●</p>	<p>contacts</p> <table border="1"> <tr> <td>7-8</td> <td></td> <td></td> <td></td> </tr> <tr> <td>5-6</td> <td></td> <td></td> <td></td> </tr> <tr> <td>3-4</td> <td></td> <td></td> <td></td> </tr> <tr> <td>1-2</td> <td></td> <td></td> <td></td> </tr> </table> <p>- 90° 0 + 90° positions</p>	7-8				5-6				3-4				1-2											
7-8																										
5-6																										
3-4																										
1-2																										
	<p><b>FCR003</b></p> <p>Single speed 4 positions Without mechanical interlock</p>	<p>contacts</p> <table border="1"> <tr> <td>3-4</td> <td></td> <td></td> <td></td> <td></td> </tr> <tr> <td>1-2</td> <td></td> <td></td> <td></td> <td></td> </tr> </table> <p>0 90° 180° 270° positions</p>	3-4					1-2																		
3-4																										
1-2																										
	<p><b>FCR004</b></p> <p>Single speed 4 positions Without mechanical interlock</p>	<p>contacts</p> <table border="1"> <tr> <td>5-6</td> <td></td> <td></td> <td></td> <td></td> </tr> <tr> <td>1-2</td> <td></td> <td></td> <td></td> <td></td> </tr> </table> <p>0 90° 180° 270° positions</p>	5-6					1-2																		
5-6																										
1-2																										
	<p><b>FCR005</b></p> <p>Single speed 4 positions Without mechanical interlock</p>	<p>contacts</p> <table border="1"> <tr> <td>5-6</td> <td></td> <td></td> <td></td> <td></td> </tr> <tr> <td>1-2</td> <td></td> <td></td> <td></td> <td></td> </tr> </table> <p>0 90° 180° 270° positions</p>	5-6					1-2																		
5-6																										
1-2																										
	<p><b>FCR006</b></p> <p>Double speed 4 positions With mechanical interlock ●</p>	<p>contacts</p> <table border="1"> <tr> <td>7-8</td> <td></td> <td></td> <td></td> <td></td> <td></td> </tr> <tr> <td>5-6</td> <td></td> <td></td> <td></td> <td></td> <td></td> </tr> <tr> <td>3-4</td> <td></td> <td></td> <td></td> <td></td> <td></td> </tr> <tr> <td>1-2</td> <td></td> <td></td> <td></td> <td></td> <td></td> </tr> </table> <p>- 180° - 90° 0 + 90° + 180° positions</p>	7-8						5-6						3-4						1-2					
7-8																										
5-6																										
3-4																										
1-2																										

POSITION LIMIT SWITCHES

# FFH2C-1

## Position limit switch

### Position limit switch

The FFH2C-1 position limit switch is used to control several handling systems:

- **Bridge cranes:** the limit switch controls the operating system, for example a PLC, and allows the bridge crane to slow down or stop.
- **Hoists:** the limit switch is used to stop the hoist whenever it reaches a limit position.

### Features

- Designed to guarantee excellent performance in the most challenging operating conditions.
- Arranged with 4 fixing holes.
- Positive opening NC contacts for safety functions.
- IP65 protection degree.
- Aluminium rod with 6x6 mm section and enclosure in thermoplastic material.
- Equipped with rod with roller with 65° movements and spring return.
- Arranged for 2 outputs for cable clamps to reduce installation time and make wiring easier.

### Compliance and certifications

- 2014/35/UE - 2011/65/UE - 2015/863/UE
- EN 60947-1 (2007/A1 : 2011/A2 : 2014)
- EN 60947-3 (2009/A1 : 2012/A2 : 2015)
- EN 60204-1 (2006/A1 : 2009)
- EN 60529 (1991/A1 : 2000/A2 : 2013)
- EN 50581 (2012)
- IEC 63000 (2016)



### Available codes



FFH2C-1  
Internal  
cam switch  
PX20 line



 contact open  contact close

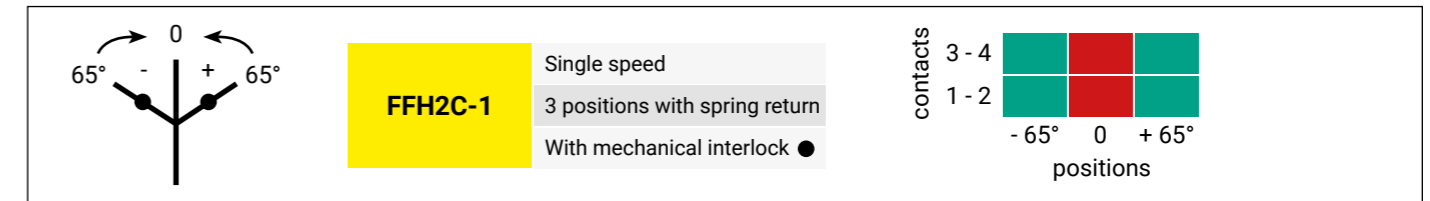

Other configurations on request.

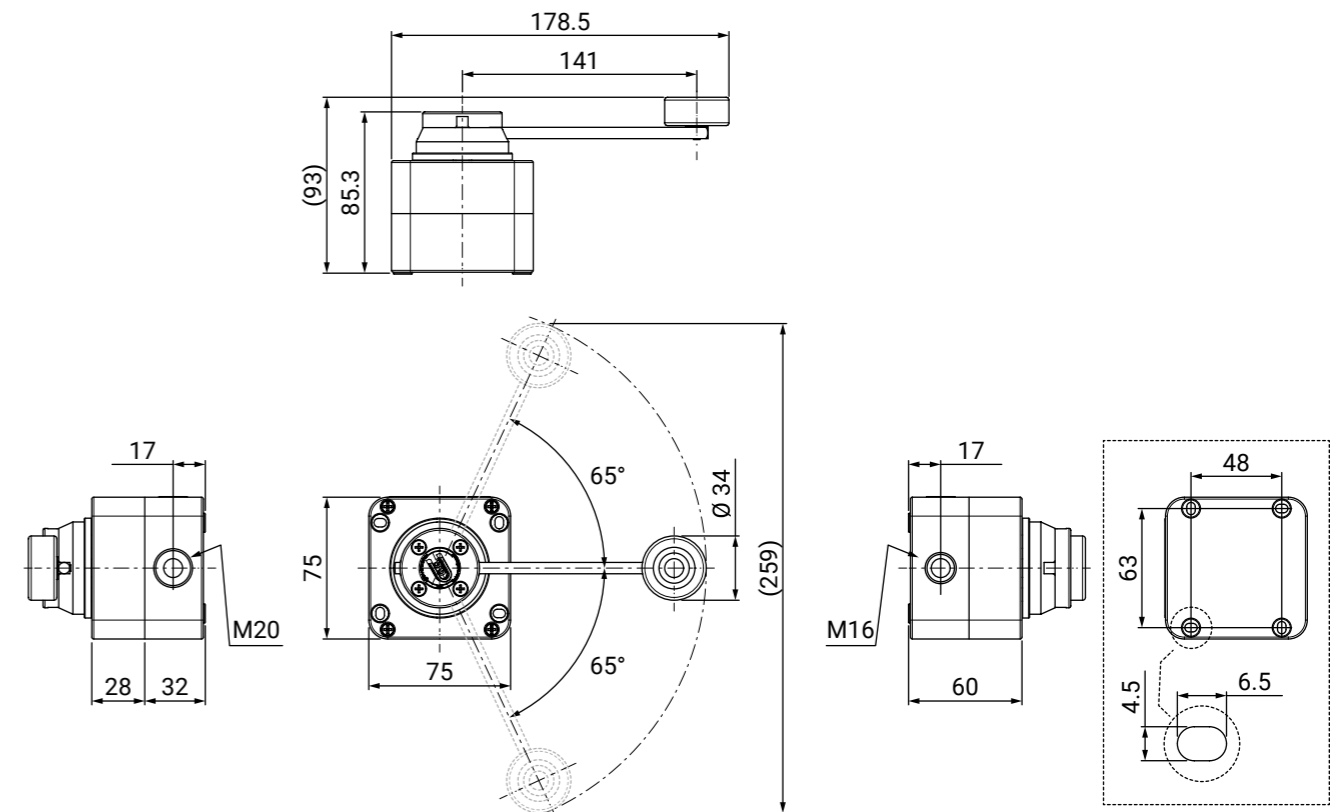

# FCP245

## Position limit switch

### Position limit switch

The FCP245 position limit switch is used to control several handling systems:

- **Hoists:** the limit switch is used to stop the hoist whenever it reaches a limit position.

### Features

- Designed to guarantee excellent performance in the most challenging operating conditions.
- Arranged with 4 fixing holes.
- Positive opening NC contacts for safety functions.
- IP65 protection degree.
- Aluminium rod and lever, enclosure in thermoplastic material.
- Equipped with lever with 50° movements and spring return.
- Arranged for 2 outputs for cable clamps to reduce installation time and make wiring easier.

### Compliance and certifications

- 2014/35/UE - 2011/65/UE - 2015/863/UE
- EN 60947-1 (2007/A1 : 2011/A2 : 2014)
- EN 60947-3 (2009/A1 : 2012/A2 : 2015)
- EN 60204-1 (2006/A1 : 2009)
- EN 60529 (1991/A1 : 2000/A2 : 2013)
- EN 50581 (2012)
- IEC 63000 (2016)



### Available codes

**FCP245**  
Internal  
cam switch  
CX40 line



 contact open  contact close

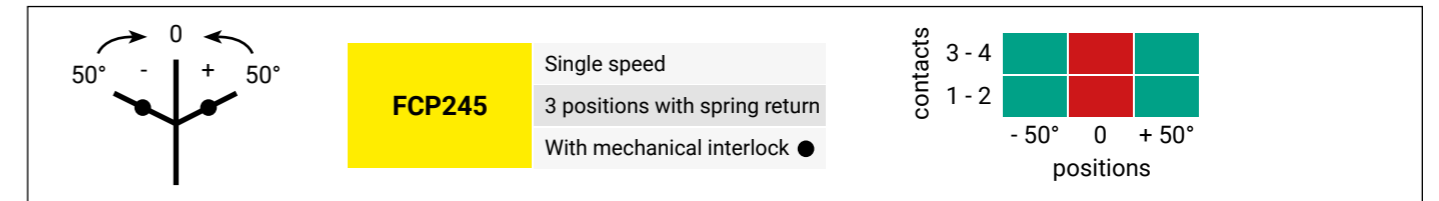

Other configurations on request.

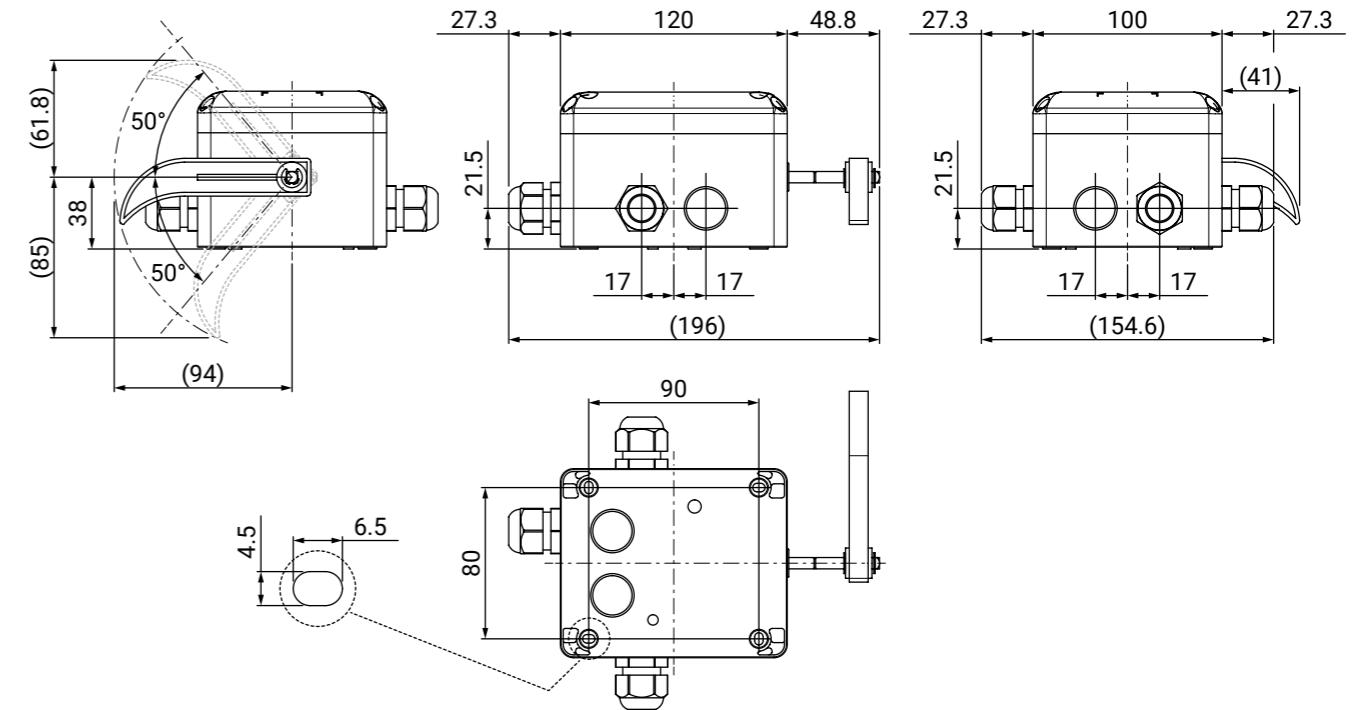

# SLIP RINGS

A **slip ring** is an electromechanical device that facilitates the transmission of electrical power and signals from a static to a moving part.

Slip ring is very important component that can solve the 360° continuous rotating and get electricity to a continuously rotating part of assembly, rotate without limits.

Slip rings can enhance the mechanical performance of a machine, streamline system functionality, and eradicate damage-prone wires hanging from rotating joints.

They function by making continuous electrical connections from stationary systems to rotating systems.

Our products guarantee a reliable operation of the whole equipment system.

## APPLICATIONS

**Slip rings** are used in electromechanical device including rotating table, surveillance systems like radars, medical machines like microscope and support arm lamps, renewable energy sources like wind turbines, automation equipment.

They are used in almost all electromechanical machines which call for unrestricted, discontinuous or continuous spinning while conducting power and signals.



## FEATURES

**Slip rings** are used to transfer electrical signal and power energy between stator and a rotor or vice versa.

They are comprised of 3 or more metal contacts, mounted on the steel shaft. The contact brushes are all replaceable and are in copper.

- **OPERATING TIME:** The operating life of a slip ring depends on the rotation speed and the dynamic stability.
- **CURRENT RATING:** Capacity can be increasing by connecting in series or parallel two or more slip rings.
- **SPEED OPERATION:** Max rotation speed 20 turns 1'.

RINGS NR.	CODE	A (HEIGHT)
3	30402091	180
4	30402092	195
5	30402093	210
6	30402094	225
7	30402095	240
8	30402096	255
9	30402097	270
10	30402098	285
11	30402099	300
12	30402100	315
13	30402101	330
14	30402102	345
15	30402103	360

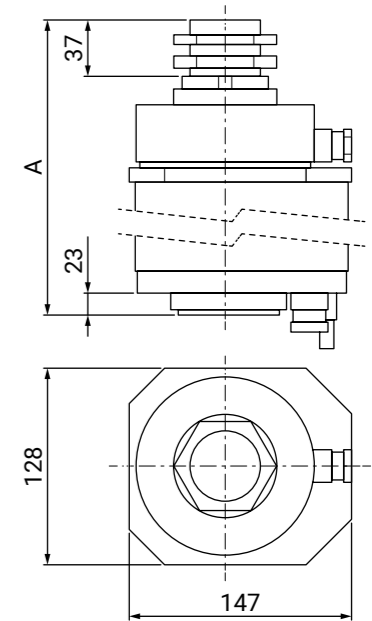

## TECHNICAL DATA

- Rated insulation voltage  $U_i$  690V.
- Rated operating voltage  $U_e$  500Vac.
- Rated operating current 20A.
- Intermittent working 30A.
- IP51 close frame version with protection rated IEC/EN60529.
- Modularity: from 3 up to 15 rings  $\varnothing$ 80 mm.
- Copper brushes.
- Shaft  $\varnothing$ 42 mm.
- PVC  $\varnothing$ 147 mm housing and terminals cover.
- Ambient temperature: +60°C/-30°C.





**GIOVENZANA INTERNATIONAL B.V.**

Strawinskylaan, 1105  
1077 XX Amsterdam, **THE NETHERLANDS**  
Ph: +31 (0) 20.4413576  
Fax: +31 (0) 20.4413456  
E-mail: [giovenzana@giovenzana.com](mailto:giovenzana@giovenzana.com)

**G.T.R. LLC**

Likhov lane, h.3, b.2, office 101  
127051, Moscow, **RUSSIAN FEDERATION**  
Ph: +7.495.6991296 / +7.499.9228548  
Fax: +7.495.6991520  
E-mail: [gtr@giovenzana.com](mailto:gtr@giovenzana.com)

**GIOVENZANA CONTROLS INDIA Pvt. Ltd.**

A-102, Knox Plaza, Chincholi, Off Link Road  
Near Mindspace, Malad West  
400064 Mumbai, **INDIA**  
Ph: +91.22.42640071  
E-mail: [ggindia@giovenzana.com](mailto:ggindia@giovenzana.com)

**GIOVENZANA CONNECTING BRASIL LTDA**

Rua Dante Razeira, 102 Cep. 92700-090  
Guaíba, Rio Grande do Sul, **BRASIL**  
Ph: (+55) 51 3055 1033  
E-mail: [gcb@giovenzana.com](mailto:gcb@giovenzana.com)

**GIOVENZANA INTERNATIONAL B.V. - Dubai Branch**

Jafza 15, Jebel Ali Free Zone  
P.O. Box 262146 Dubai - **U.A.E.**  
Ph: +971.4.8870788  
Fax: +971.4.8870787  
E-mail: [uae@giovenzana.com](mailto:uae@giovenzana.com)



**WWW.GIOVENZANA.COM**